



WENDELBO

Catalog |

Suggested retail
Excl. VAT
EX WORKS / EUR

Sofa

Technical sheet

WENDELBO



Blade /

Clean and contemporary

Drawn with a sharp outline and elongated loose seat cushions, the Blade Sofa prompts a clean and contemporary look, further elevated by slim legs in black powder-coated aluminium. Soft down-fill scatter and back cushions add a customised character to the design while enhancing the level of comfort.

DESIGNER

365 North

CATEGORY

Modular sofas

TEST

EN 16139

ASSEMBLY

Follow assembly instructions for mounting of legs

LEGS

Black powder-coated steel

**STRUCTURE INTERIOR**

Frame made of steel, solid wood and MDF with nozag spring system

STRUCTURE PADDING

High-resilient, variable density, polyurethane foam.

SEAT CUSHION

High-resilient foam and downtop

BACK CUSHION

100% down/feathers
Back cushions are not included

MAINTENANCE

Loose seat- and back cushions, or filling with down and feathers, should be patted down regularly to maintain their shape. Cushions and scatters should be shaken and fluffed up regularly to maintain their shape. To ensure the longevity of your product, please follow our care and maintenance guides. All guides can be downloaded at wendelbo.com/care

WARRANTY

5 years

Module 1

3.5 seater*

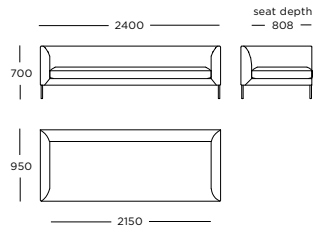

Module 2

3 seater*

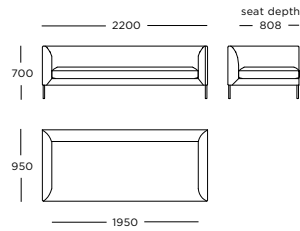

Module 3

2.5 seater*

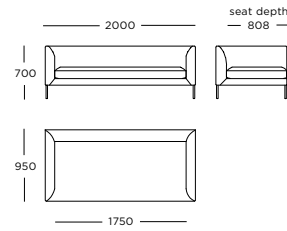

Module 4

2 seater*

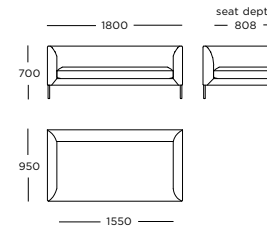

Module 5

3.5 seater, left arm*

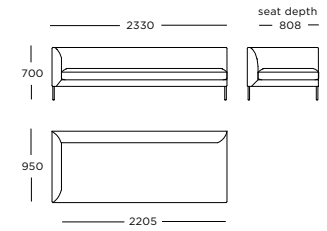

Module 6

3.5 seater, right arm*

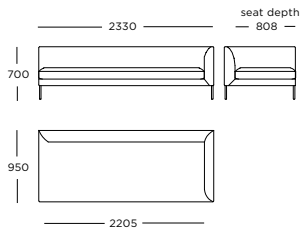

Module 7

3 seater, left arm*

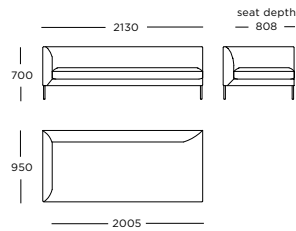

Module 8

3 seater, right arm*

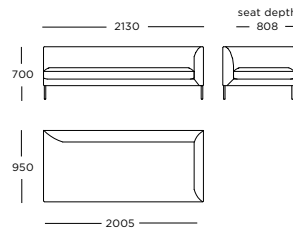

Module 9

2.5 seater, left arm*

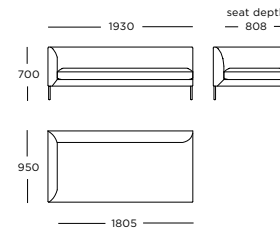

Module 10

2.5 seater, right arm*

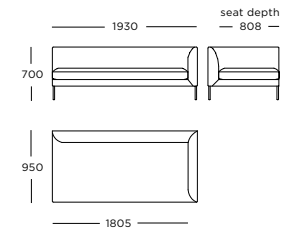

Module 11

2 seater, left arm*

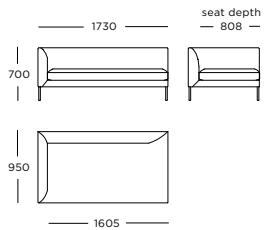

Module 12

2 seater, right arm*

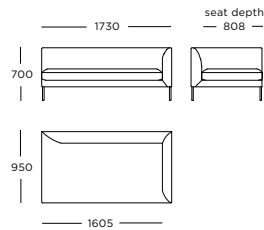

Module 13

2 seater, chaise no arms - wide

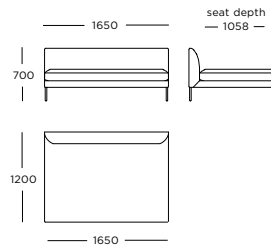

Module 14

2 seater, chaise no arms - long

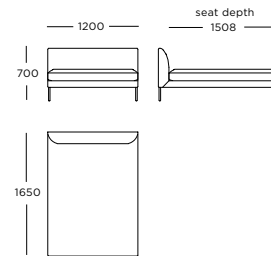

Module 15

2 seater, terminal left arm - wide

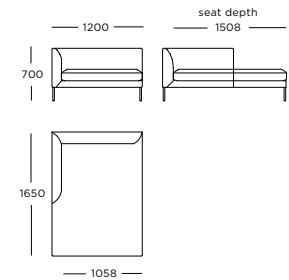

Seat height: 420 mm

* Back cushions are not included

Module 16

2 seater, terminal right arm - wide*

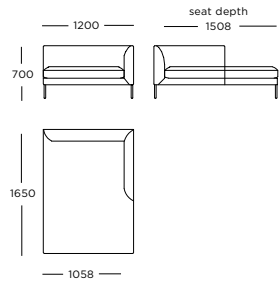

Module 17

2 seater, chaise open back - left*

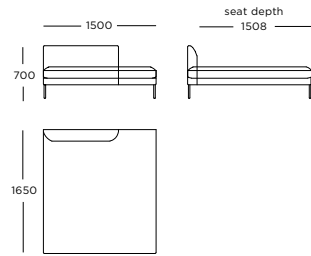

Module 18

2 seater chaise open back - right*

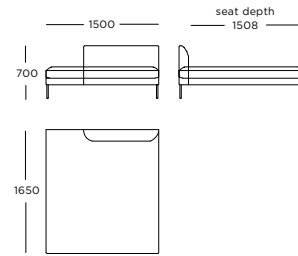

Module 19

2 seater, terminal left arm - long*

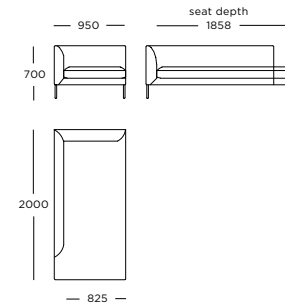

Module 20

2 seater, terminal right arm - long*

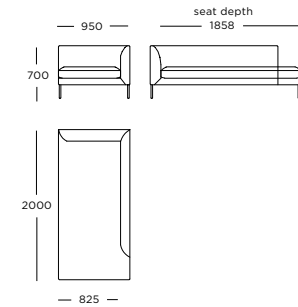

Module 21

Corner*

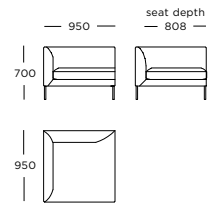

Module 22

Centre*

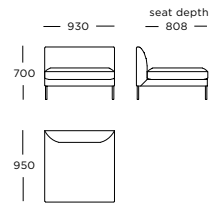

Module 23

Stool

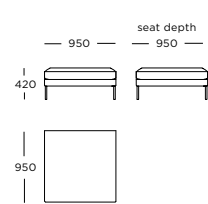

Seat height: 420 mm

* Back cushions are not included

Configuration 1

Modules 9 + 20

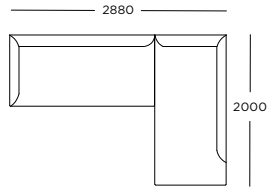

Configuration 2

Modules 9 + 17

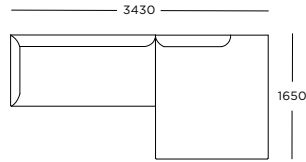

Configuration 3

Modules 9 + 21 + 12

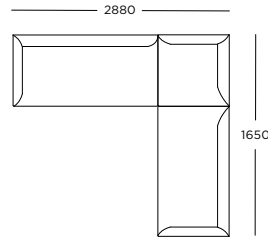

Configuration 4

Modules 15 + 12

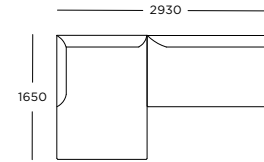

Configuration 5

Modules 15 + 22 + 23

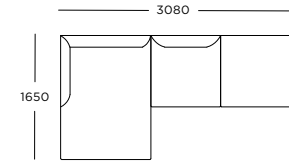

Configuration 6

Modules 19 + 10 + 23

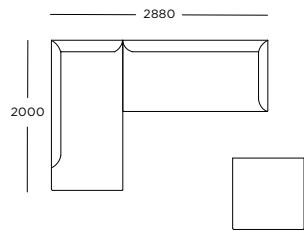

Configuration 7

Modules 1 + 7

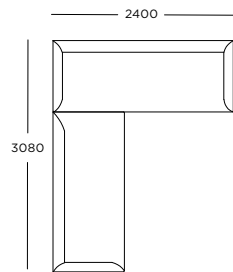

Configuration 8

Modules 15 + 22 + 22

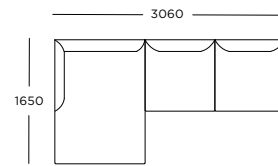



Boketto /

The art of non-doing

Drawing inspiration from the Japanese philosophy of 'Boketto,' a practice rooted in the art of non-doing and peaceful reflection, the Boketto Sofa is defined by gently rounded rectangles, offering a soothing, cohesive look. Two diagonal modules add versatility to layouts, while modules with trays provide a functional touch.

DESIGNER

Lars Wendelbo

CATEGORY

Modular sofas

ASSEMBLY

Assembled upon receipt

LEGS

Black stained solid oak

STRUCTURE INTERIOR

Frame made of solid wood, plywood and MDF with nozag spring system

STRUCTURE PADDING

High-resilient, variable density, polyurethane foam with dacron padding

SEAT AND BACK

High-resilient, variable density, polyurethane foam with dacron padding

BACK CUSHION

100% down top/feathers top in down proof cambric divided into channels with removable cover.

COVER

Fixed

TRAY AND MARBLE TOP

Tray: Black stained, dark brown stained, or light oak veneer

Marble top: Pietra Grey

Powerdot Micro with 1 x USB Type A & C



MAINTENANCE

To ensure the longevity of your product, please follow our care and maintenance guides. All guides can be downloaded at wendelbo.com/care

WARRANTY

5 years

Module 1

1 seater, side left

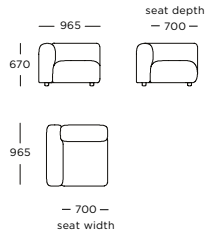

Module 2

1 seater, side right

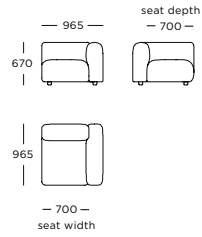

Module 3

1.5 seater, side left

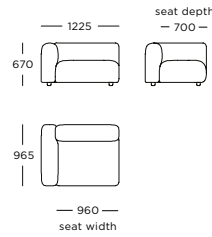

Module 4

1.5 seater, side right

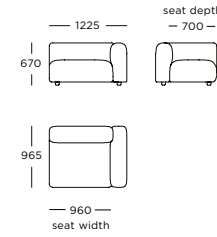

Module 5

2 seater, side left

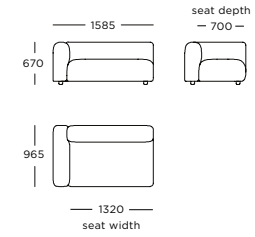

Module 6

2 seater, side right

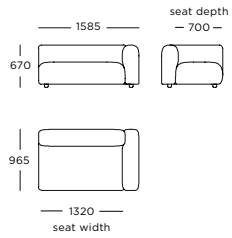

Module 7

1 seater, centre

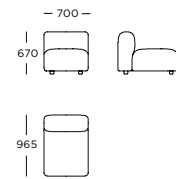

Module 8

1.5 seater, centre

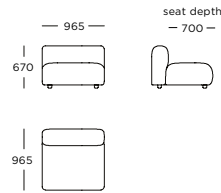

Module 9

Pouf

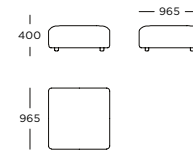

Module 10

2 seater, open end, side right

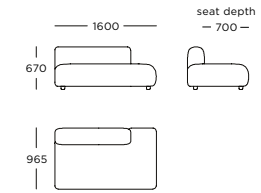

Module 11

2 seater, open end, side left

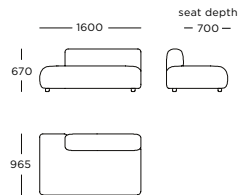

Module 12

2.5 seater, open end, side right

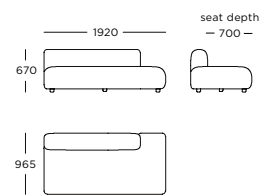

Module 13

2.5 seater, open end, side left

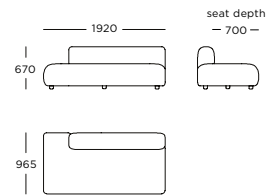

Module 14

Chaise longue, side left

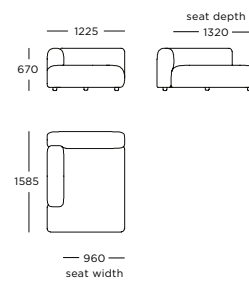

Module 15

Chaise longue, side right

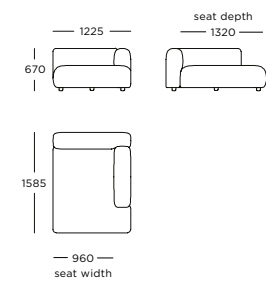

Seat height: 400 mm
Back cushions are not included

Boketto / Module overview

Index



Fabrics



Leather



Module 16

Pouf with wooden tray and marble plate
1 x USB Type A & C charging connector

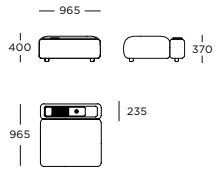

Module 17

Angled chaise longue, side left

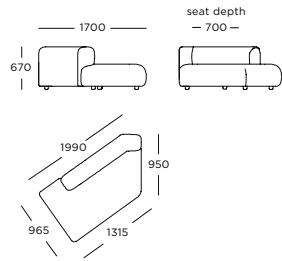

Module 18

Angled chaise longue, side right

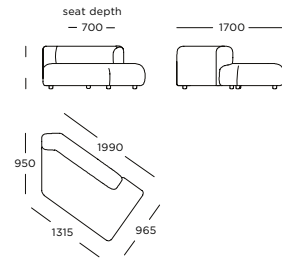

Module 19

Module with wooden tray and marble plate
1 x USB Type A & C charging connector

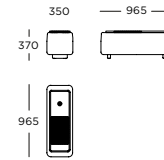

Seat height: 400 mm
Back cushions are not included

Configuration 1

Modules 3 + 4

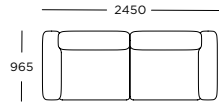

Configuration 2

Modules 1 + 7 + 2

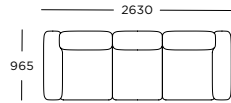

Configuration 3

Modules 3 + 8 + 4



Configuration 4

Modules 3 + 16 + 4

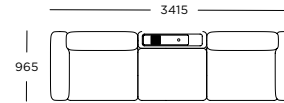

Configuration 5

Modules 5 + 18

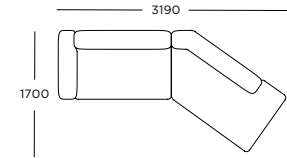

Configuration 6

Modules 17 + 19 + 6

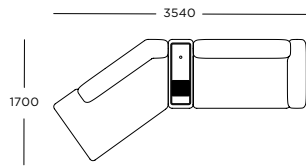

Configuration 7

Modules 14 + 6

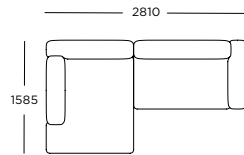

Configuration 8

Modules 5 + 10

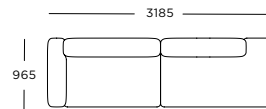

Configuration 9

Modules 11 + 1 + 6

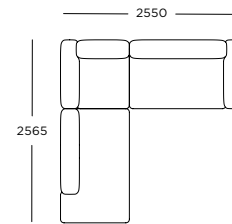

Configuration 10

Modules 13 + 8 + 15

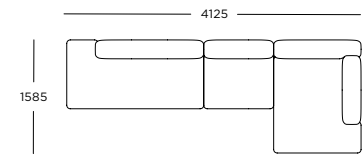

Configuration 11

Modules 17 + 8 + 18

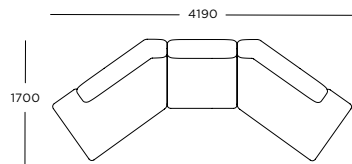



Case / Continuum of comfort

Resting atop an elegant wooden base, simple and slender lines leave the Case collection with a stringent and light expression without compromising on the comfort and function of the design. The collection features three sofa designs as well as two Case Hubs, breathing the cocooning comfort and calmness of the home into the realms of workplace and hospitality settings.

DESIGNER

Sebastian Herkner

CATEGORY

High back sofas
Sofas
Hubs

TEST

EN 16139
GB
BIFMA

ASSEMBLY

Follow instructions for assembly of sofa and table

BASE

Black stained solid oak



STRUCTURE INTERIOR

Frame made of solid wood, steel and MDF with nozag spring system

STRUCTURE PADDING

High-resilient, polyurethane foam

SEAT CUSHION

High-resilient, polyurethane foam with dacron padding

BACK CUSHION

High-resilient, polyurethane foam with dacron padding

COVER

Removable back and seat cushion cover.
Side cushion cover is not removable.

STEEL TABLE

Black powder-coated steel.
The table can be mounted in either the middle, right or left side

WOODEN TABLE

MDF with oak veneer



MAINTENANCE

To ensure the longevity of your product, please follow our care and maintenance guides. All guides can be downloaded at wendelbo.com/care

WARRANTY

5 years

High back

2.5 seater

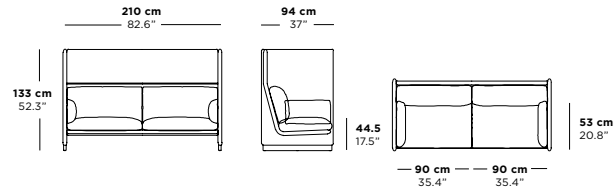

High back

2 seater

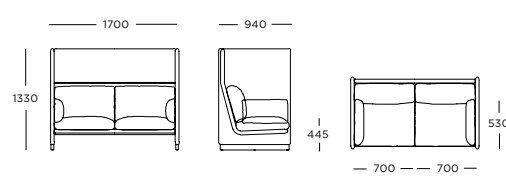

High back

1.5 seater

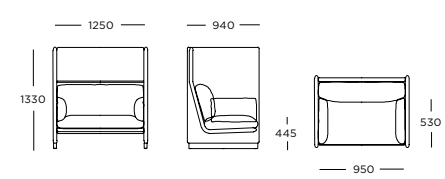

Low back

2.5 seater

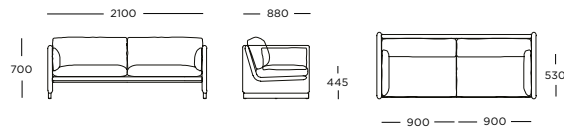

Low back

2 seater

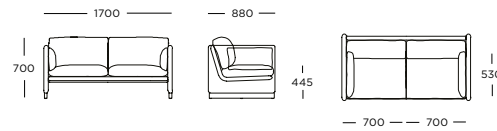

Low back

1.5 seater

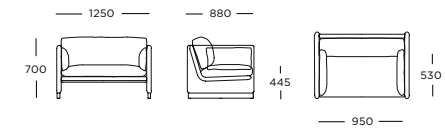

Combi

2 seater

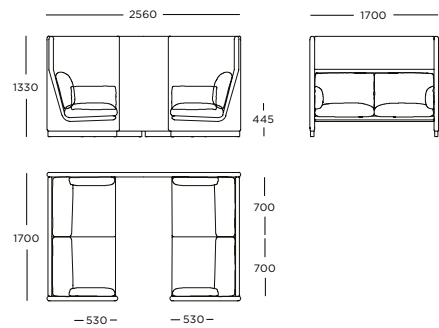

Combi

2 seater with wooden table

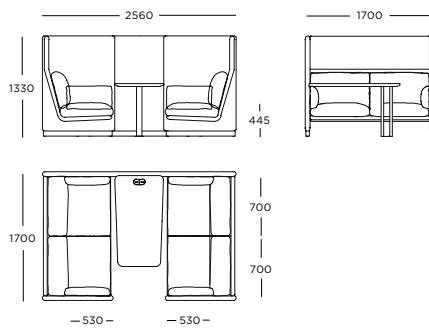

Combi

1.5 seater

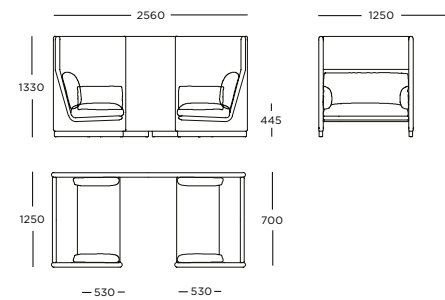

Seat height: 445 mm

Case / Overview

Index



Fabrics



Leather



Case Hub

V1

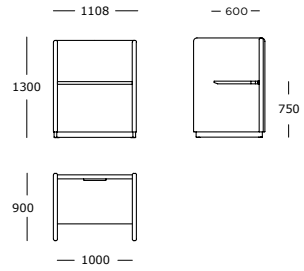

Case Hub

V2

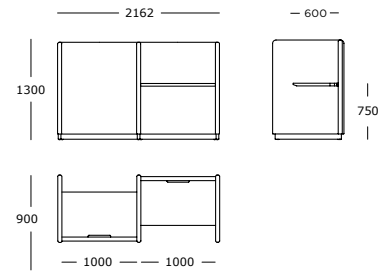

Additional | Mounted table, plug and USB charger

High back / Low back
2.5 seater

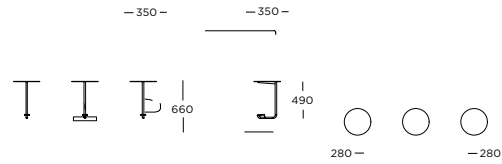

High back / Low back
2 seater

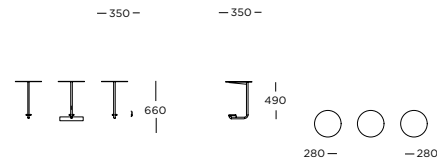

High back / Low back
1.5 seater

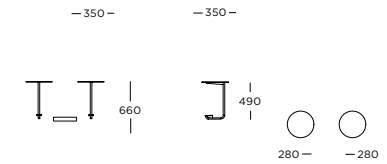

Combi
2 seater

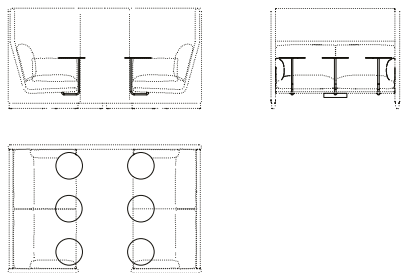

Combi
1.5 seater

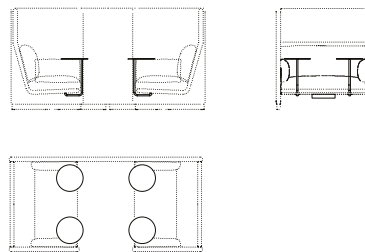

Plug and USB charger
307 x 52 mm





Cinder Block /

A floating island

Lending its name from light-weight low-density construction blocks, the massive design of the modular Cinder Block sofa is balanced by the rounded upholstered components and black-stained, barely visible, legs, making the dense design resemble a floating island.

DESIGNER

Luca Nichetto

CATEGORY

Modular sofas

TEST

EN 16139

ASSEMBLY

Assembled upon receipt

LEGS

Black stained solid wood

STRUCTURE INTERIOR

Frame made of solid wood and MDF with webbing spring system

STRUCTURE PADDING

High-resilient, variable density, polyurethane foam with dacron padding

SEAT

High-resilient, variable density, polyurethane foam with dacron padding

BACK CUSHION

50/50 feathers and ball fibres in down-proof cambric divided into channels

COVER

Fixed
Removable back cushion cover

TABLE

Frame is black powder-coated steel
Top and base is black or dark brown stained oak veneer



MAINTENANCE

Loose back cushions, or filling with down and feathers, should be patted down regularly to maintain their shape. Cushions and scatters should be shaken and fluffed up regularly to maintain their shape. To ensure the longevity of your product, please follow our care and maintenance guides. All guides can be downloaded at wendelbo.com/care

WARRANTY

5 years

Module 1

1 seater, left arm

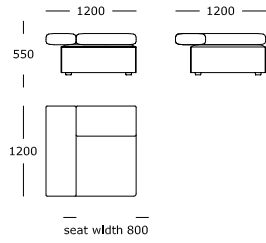

Module 2

1 seater, right arm

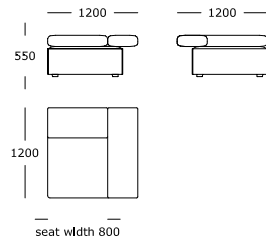

Module 3

1 seater, end-terminal, right

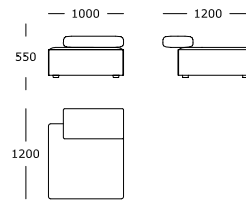

Module 4

1 seater, end-terminal, left

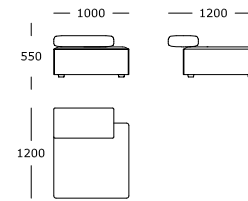

Module 5

Small centre

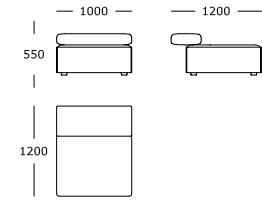

Module 6

Long centre

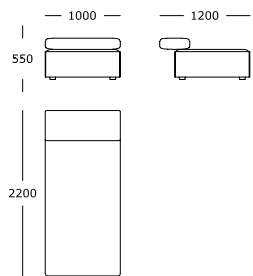

Module 7

Small stool

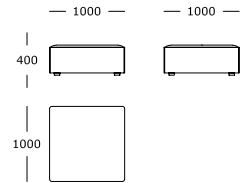

Module 8

2 seater, terminal, left arm

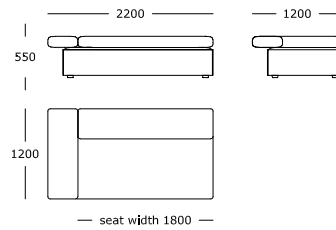

Module 9

2 seater, terminal, right arm

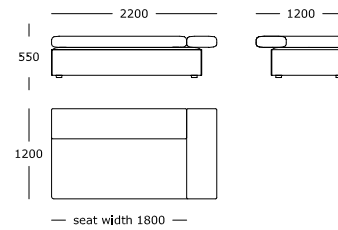

Module 10

2.5 seater, end-terminal, right

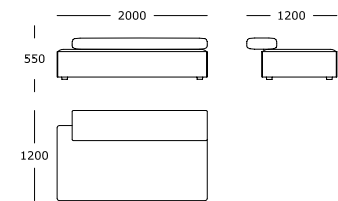

Module 11

2.5 seater, end-terminal, left

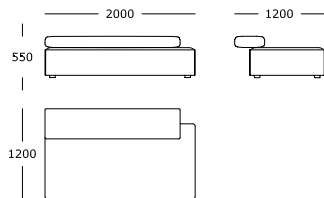

Module 12

Large centre

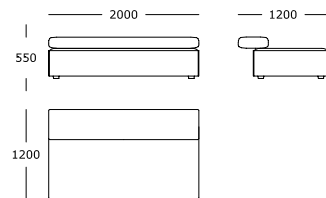

Module 13

2 seater, chaise left

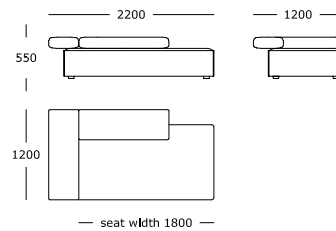

Module 14

2 seater, chaise right

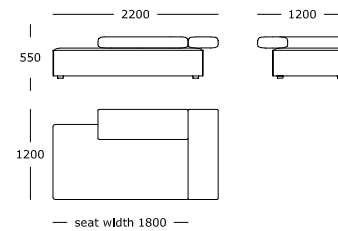

Module 15

Long stool

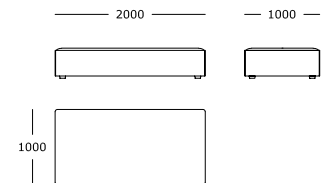

Seat height: 400 mm
Back cushions are not included

Cinder Block / Module overview

Index



Fabrics



Leather



Module 16

1.5 seater, left arm

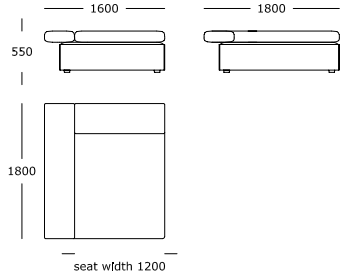

Module 17

1.5 seater, right arm

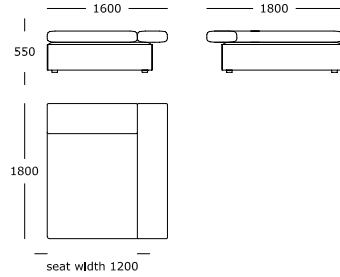

Module 18

1.5 seater, end-terminal, right

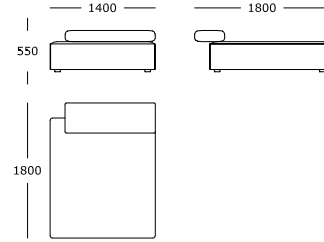

Module 19

1.5 seater, end-terminal, left

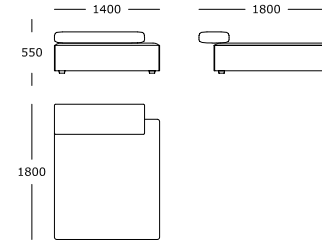

Module 20

1.5 seater, chaise left

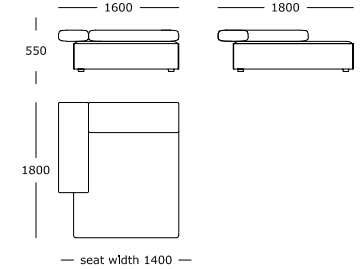

Module 21

1.5 seater, chaise right

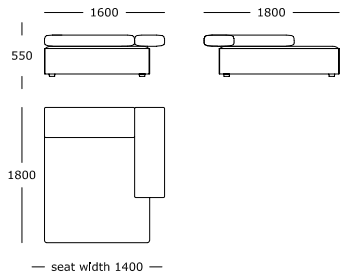

Module 22

Large centre

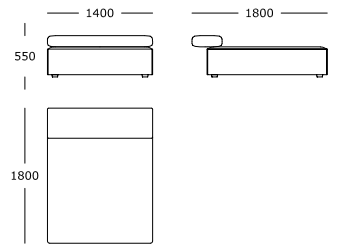

Module 23

Large stool

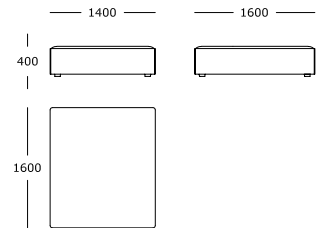

Module 24

1.5 seater, chaise no back, small arm

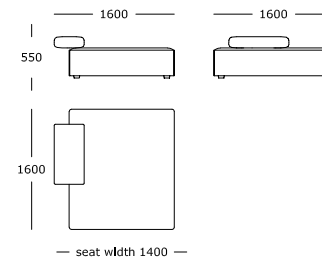

Module 25

1.5 seater, chaise no back, small arm

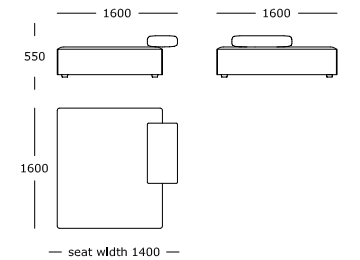

Module 26

1.5 seater, chaise no back, medium arm

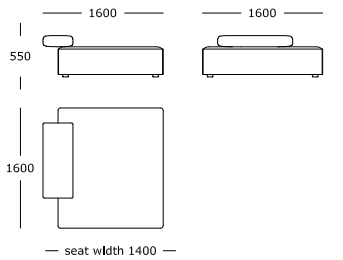

Module 27

1.5 seater, chaise no back, medium arm

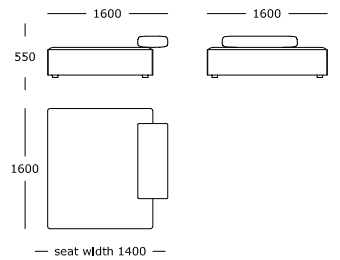

Module 28

1.5 seater, chaise large, left

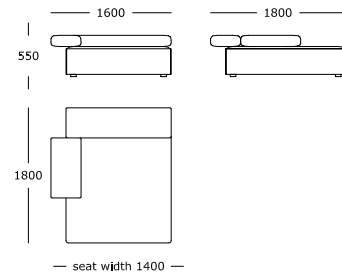

Module 29

1.5 seater, chaise large, right

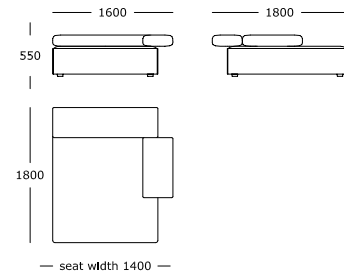

Module 30

1.5 seater, chaise large, left

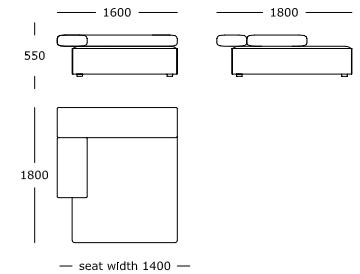

Seat height: 400 mm
Back cushions are not included

Cinder Block / Module overview

Index



Fabrics



Leather



Module 31

1.5 seater, chaise large, right

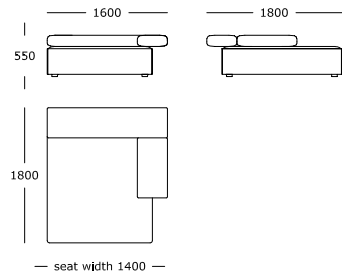

Module 32

Table

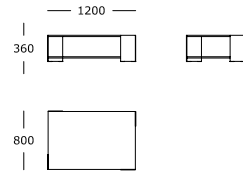

Seat height: 400 mm
Back cushions are not included

Cinder Block / Module overview

Index



Fabrics



Leather



Configuration 1

Modules 20 + 12

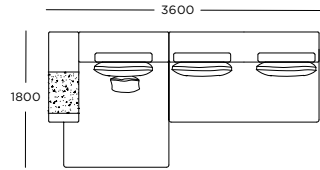

Configuration 2

Modules 1 + 9 + 18

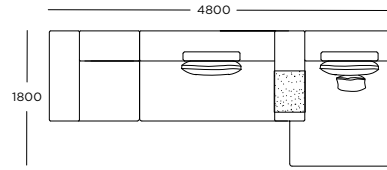

Configuration 3

Modules 2 + 10 + 8

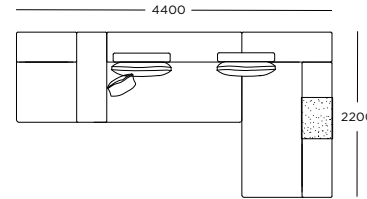

Configuration 4

Modules 30 + 12 + 31

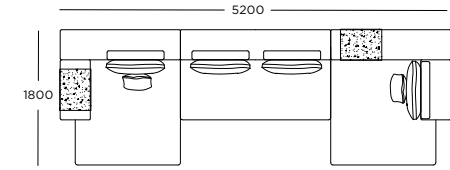

Configuration 5

Modules 15 + 1 + 3 + 1 + 3 + 15

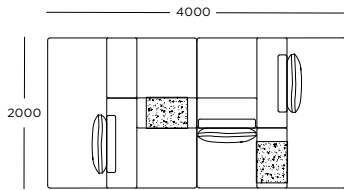

Configuration 6

Modules 3 + 15 + 31

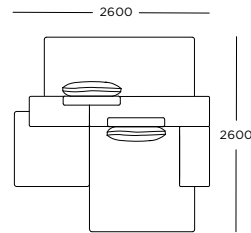

Configuration 7

Modules 5 + 15 + 28 + 25 + 12

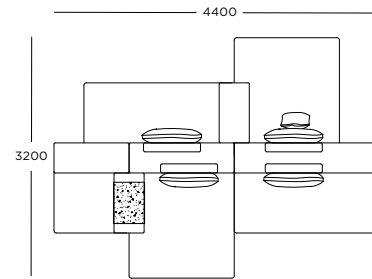

Configuration 8

Modules 11 + 15 + 20

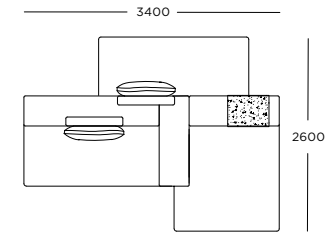

Configuration 9

Modules 11 + 19 + 15 + 20

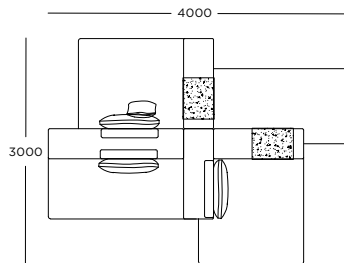

Configuration 10

Modules 14 + 32 + 20 + 32 + 13

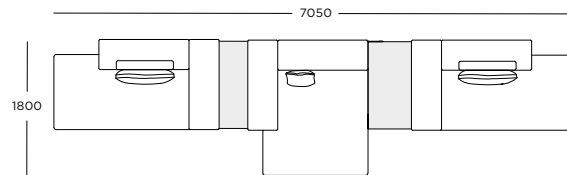

Cinder Block / Configuration examples

Index



Fabrics



Leather





Define /

A float of defining lines

Being simply rectangular and levelled in its form, the modular sofa comes with rounded triangular back and side supports that easily can be added to the design by means of indentations on the surface of the seat cushions.

DESIGNER

365 North

CATEGORY

Modular sofa

TEST

EN 16139

ASSEMBLY

Follow assembly instructions for mounting of legs and supports

LEGS

Black powder-coated steel



STRUCTURE INTERIOR

Frame made of solid wood and MDF with nozag spring system

STRUCTURE PADDING

High-resilient, variable density, polyurethane foam

SEAT CUSHION

High-resilient, variable density, polyurethane foam and fibres

BACK CUSHION

100% down/feathers

COVER

Fixed

MAINTENANCE

Loose back cushions, or filling with down and feathers, should be patted down regularly to maintain their shape. Cushions and scatters should be shaken and fluffed up regularly to maintain their shape. To ensure the longevity of your product, please follow our care and maintenance guides. All guides can be downloaded at wendelbo.com/care

WARRANTY

5 years

Module 1

2 seater
2 back supports and cushions included

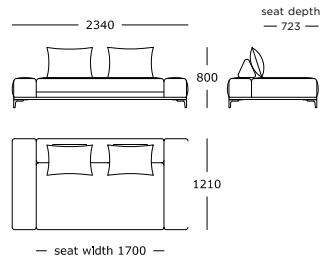

Module 2

3 seater
3 back supports and cushions included

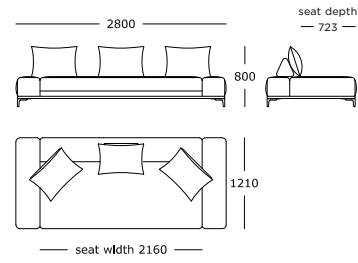

Module 3

Side, left
2 back supports and cushions included

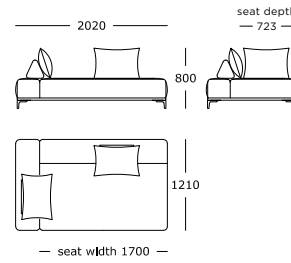

Module 4

Side, right
2 back supports and cushions included

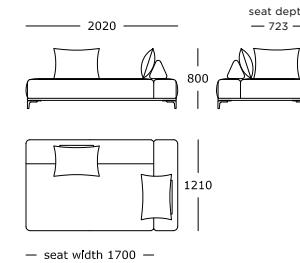

Module 5

Centre
1 back support and cushion included

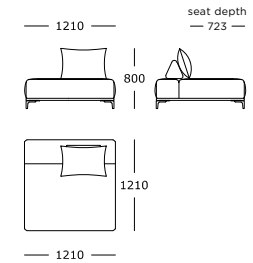

Module 6

Stool

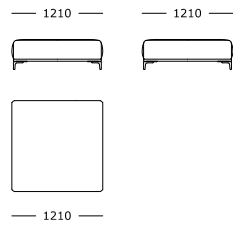

Seat height: 400 mm

Define / Module overview

Index



Fabrics



Leather



Configuration 1

Modules 3 + 4

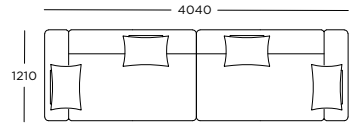

Configuration 2

Modules 3 + 3

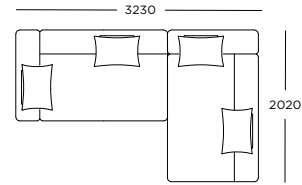

Configuration 3

Modules 2 + 4

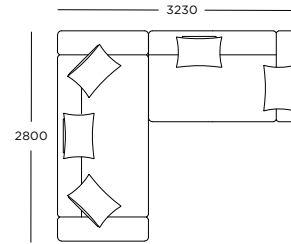

Configuration 4

Modules 3 + 6

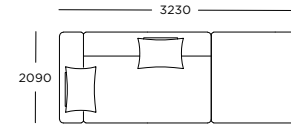



Edge V1 / Contemporary classic

Seized in a simplified silhouette, the modular Edge V1 prompts a contemporary yet timeless design that fits seamlessly into any environment. Slim legs, featuring a sharp visual edge, add lightness to the design, inviting relaxation and incomparable comfort.

DESIGNER

Lars Wendelbo

CATEGORY

Modular sofa

TEST

EN 16139
GB

ASSEMBLY

Follow assembly instructions for mounting of legs

LEGS

Black powder-coated steel
Dark brown powder-coated steel
Brushed stainless steel



STRUCTURE INTERIOR

Frame made of solid wood and MDF
with nozag spring system

STRUCTURE PADDING

High-resilient, variable density, polyurethane foam

SEAT CUSHION

High-resilient, polyurethane seat cushion with a wrap of down/feathers and ball fibres in a downproof cambric divided into channels.

BACK CUSHION

Down/feathers and ball fibres in a downproof cambric divided into channels.

COVER

Loose

MAINTENANCE

Loose seat- and back cushions, or filling with down and feathers, should be patted down regularly to maintain their shape. Cushions and scatters should be shaken and fluffed up regularly to maintain their shape. To ensure the longevity of your product, please follow our care and maintenance guides. All guides can be downloaded at wendelbo.com/care

WARRANTY

5 years

Module 1

2 seater, small

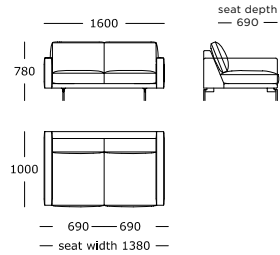

Module 2

2 seater, small, centre

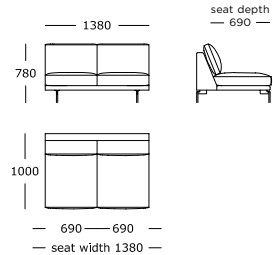

Module 3

2 seater, small, left arm

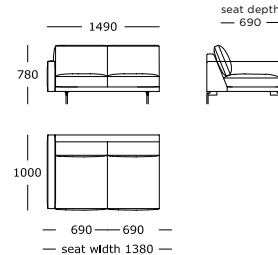

Module 4

2 seater, small, right arm

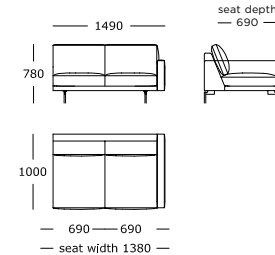

Module 5

2 seater, large

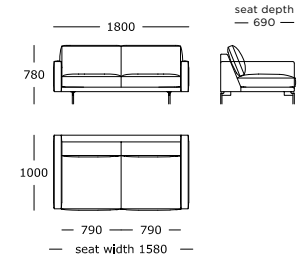

Module 6

2 seater, large, centre

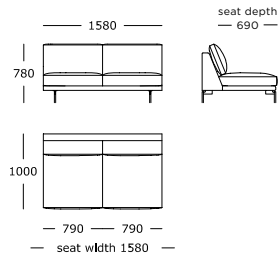

Module 7

2 seater, large, left arm

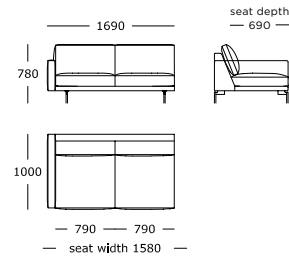

Module 8

2 seater, large, right arm

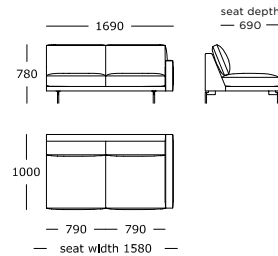

Module 9

2.5 seater, medium

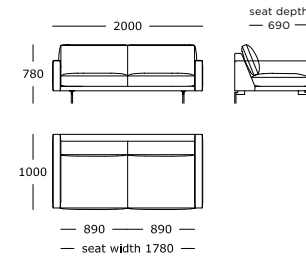

Module 10

2.5 seater, medium centre

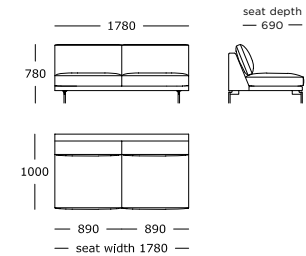

Module 11

2.5 seater, medium, left arm

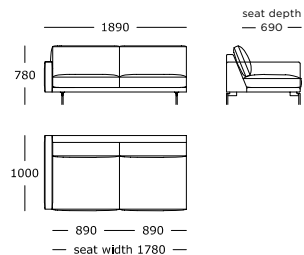

Module 12

2.5 seater, medium, right arm

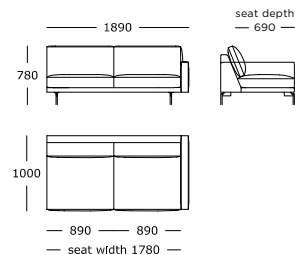

Module 13

2.5 seater, large

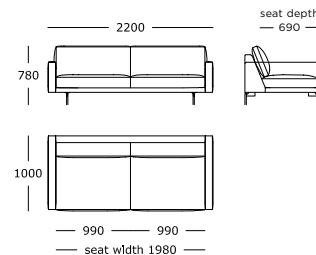

Module 14

2.5 seater, centre

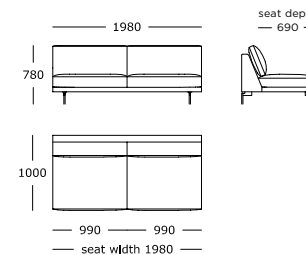

Module 15

2.5 seater, large, left arm

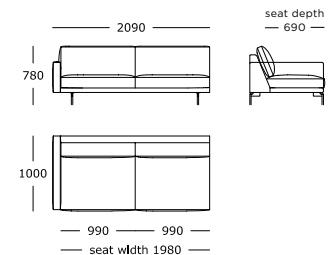

Seat height: 400 mm
 Armrest height: 565 mm
 Sofa depth: 1000 mm (standard) / 900 mm (optional)

Edge V1 / Module overview

Index



Fabrics



Leather



Module 16

2.5 seater, large, right arm

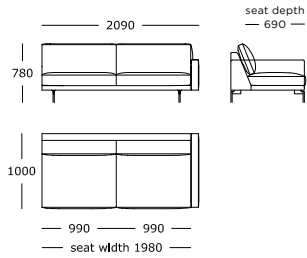

Module 17

2.5 seater, large

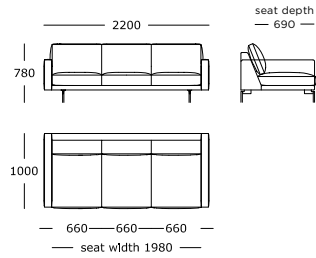

Module 18

2.5 seater, large, centre

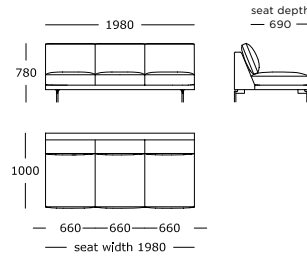

Module 19

2.5 seater, large, left arm

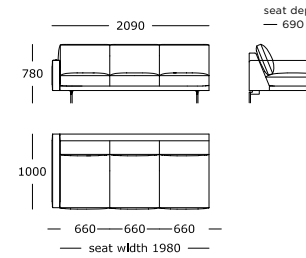

Module 20

2.5 seater, large, right arm

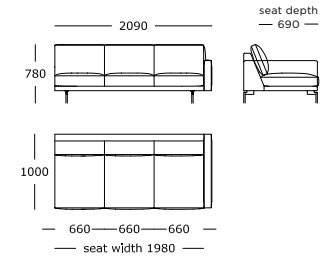

Module 21

3 seater

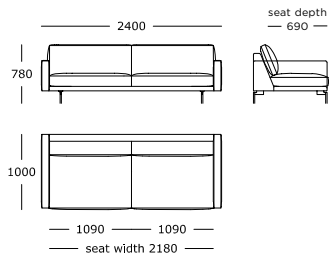

Module 22

3 seater, centre

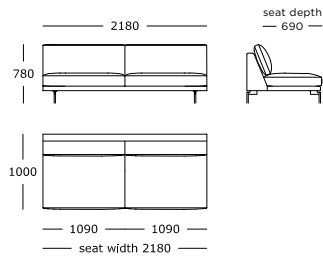

Module 23

3 seater, left arm

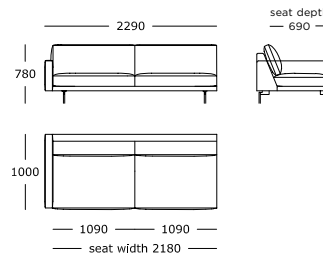

Module 24

3 seater, right arm

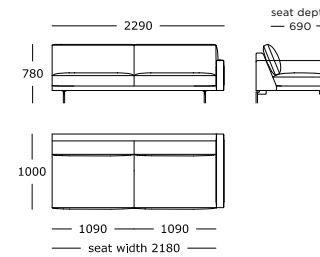

Module 25

3 seater

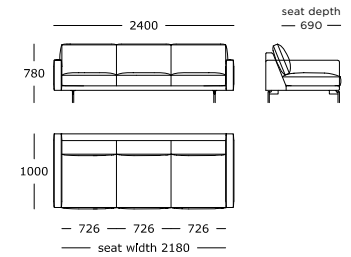

Module 26

3 seater, centre

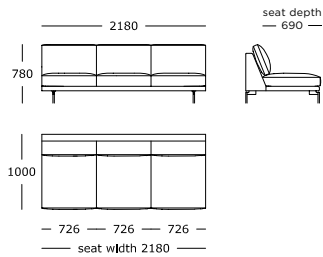

Module 27

3 seater, left arm

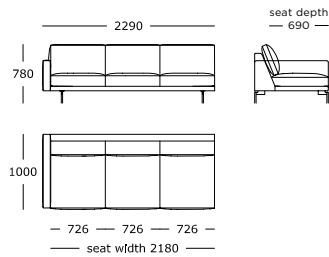

Module 28

3 seater, right arm

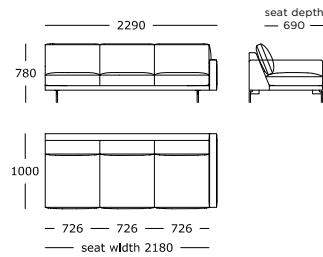

Module 29

Chaise long, left arm

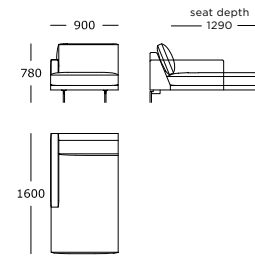

Module 30

Chaise long, right arm

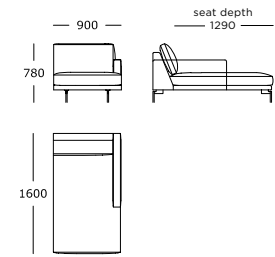

Seat height: 400 mm
 Armrest height: 565 mm
 Sofa depth: 1000 mm (standard) / 900 mm (optional)

Edge V1 / Module overview

[Index](#)



[Fabrics](#)



[Leather](#)



Module 31

End terminal, medium, right

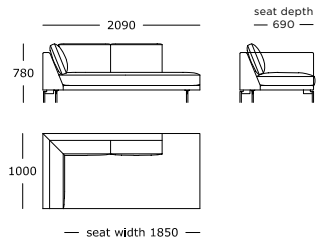

Module 32

End terminal, medium, left

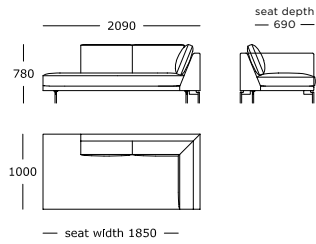

Module 33

End terminal, large, right

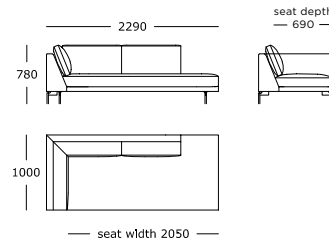

Module 34

End terminal, large, left

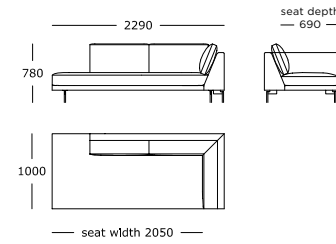

Module 35

Chair

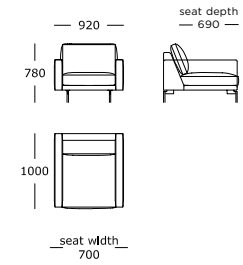

Module 36

Corner

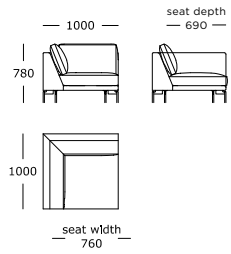

Module 37

Stool, large

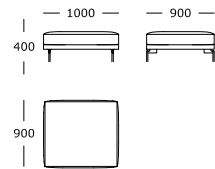

Module 38

Stool, medium

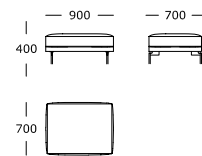

Seat height: 400 mm
 Armrest height: 565 mm
 Sofa depth: 1000 mm (standard) / 900 mm (optional)

Edge V1 / Module overview

Index



Fabrics



Leather



Configuration 1

Modules 29 + 12

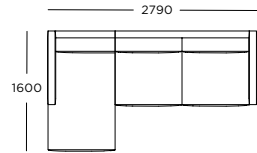

Configuration 2

Modules 23 + 31

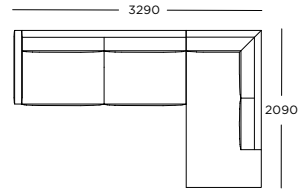

Configuration 3

Modules 7 + 36 + 8

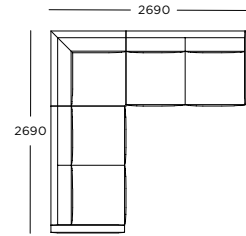

Configuration 4

Modules 32 + 14 + 31

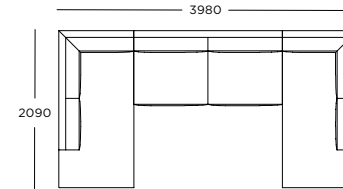

Configuration 5

Modules 29 + 14 + 31

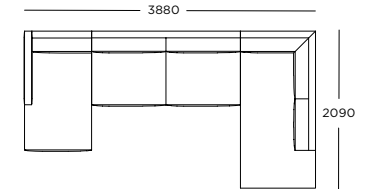



Edge V2 /

Refined lines on the edge

The Edge V2 Sofa takes its origin point in the idea of lines, running between its frame and cushion for a slight, elegant gap, across its linear armrests and throughout its soft, loose pillows. The design floats on a delicately designed base of steel.

DESIGNER

Lars Wendelbo

CATEGORY

Modular sofa

ASSEMBLY

Follow assembly instructions for mounting of legs

LEGS

Black powder-coated steel
Dark brown powder-coated steel
Brushed stainless steel



STRUCTURE INTERIOR

Frame made of solid wood and MDF
with nozag spring system

STRUCTURE PADDING

High-resilient, variable density, polyurethane foam

SEAT CUSHION

High-resilient, polyurethane seat cushion
with a wrap of fibre-fill

BACK CUSHION

Down/feathers and ball fibres in a down-proof cambric divided into channels.

COVER

Loose

MAINTENANCE

Loose seat- and back cushions, or filling with down and feathers, should be patted down regularly to maintain their shape. Cushions and scatters should be shaken and fluffed up regularly to maintain their shape. To ensure the longevity of your product, please follow our care and maintenance guides. All guides can be downloaded at wendelbo.com/care

WARRANTY

5 years

Module 1

2 seater, small
2 x back cushion M included

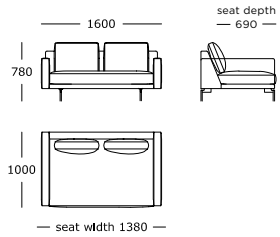

Module 2

2 seater, small, centre
2 x back cushion M included

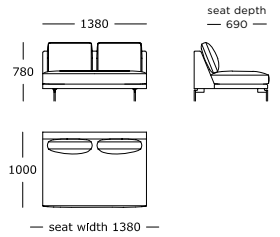

Module 3

2 seater, small, left arm
2 x back cushion M included

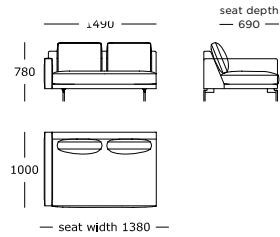

Module 4

2 seater, small, right arm
2 x back cushion M included

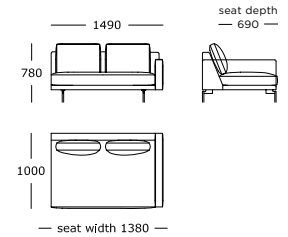

Module 5

2 seater, large
2 x back cushion M included

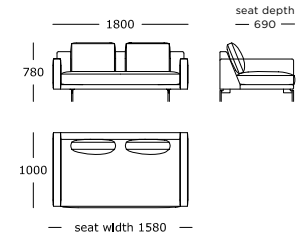

Module 6

2 seater, large, centre
2 x back cushion M included

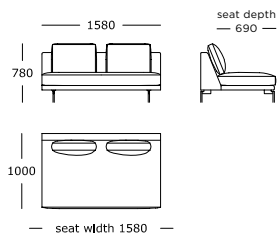

Module 7

2 seater, large, left arm
2 x back cushion M included

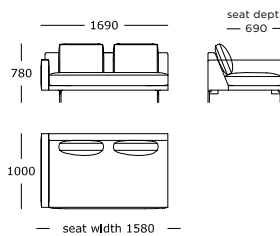

Module 8

2 seater, large, right arm
2 x back cushion M included

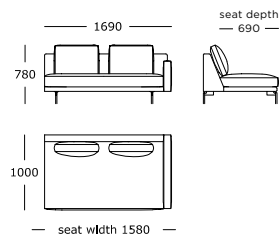

Module 9

2.5 seater, medium
2 x back cushion L included

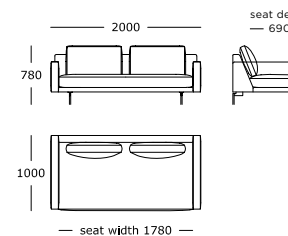

Module 10

2.5 seater, medium, centre
2 x back cushion L included

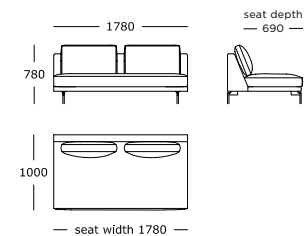

Module 11

2.5 seater, medium, left arm
2 x back cushion L included

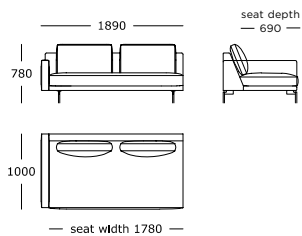

Module 12

2.5 seater, medium, right arm
2 x back cushion L included

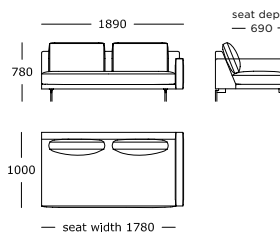

Module 13

2.5 seater, large
2 x back cushion L included

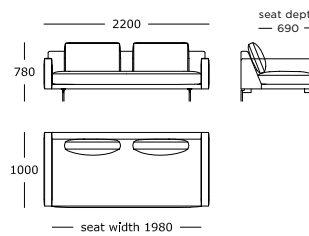

Module 14

2.5 seater, centre
2 x back cushion L included

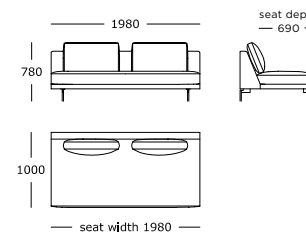

Module 15

2.5 seater, large, left arm
2 x back cushion L included

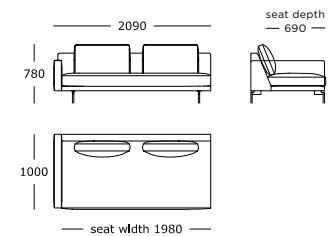

Seat height: 400 mm
Armrest height: 565 mm
Sofa depth: 1000 mm (standard) / 900 mm (optional)

Edge V2 / Module overview

Index



Fabrics



Leather



Module 16

2.5 seater, large, right arm
2 x back cushion L included

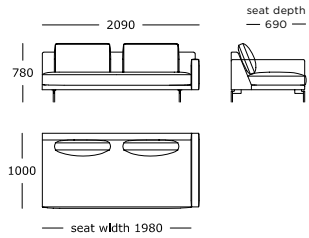

Module 17

2.5 seater, large
3 x back cushion M included

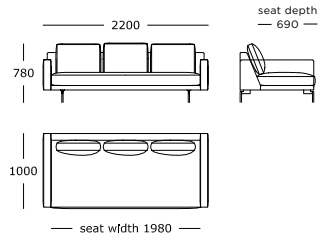

Module 18

2.5 seater, large, centre
3 x back cushion M included

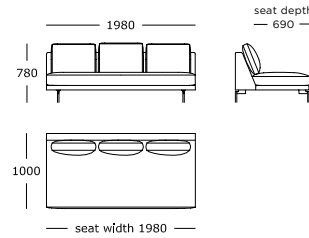

Module 19

2.5 seater, large, left arm
3 x back cushion M included

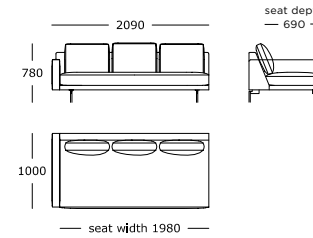

Module 20

2.5 seater, large, right arm
3 x back cushion M included

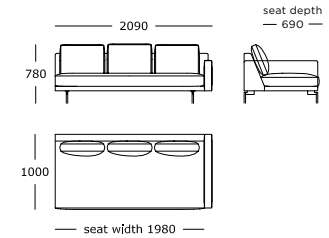

Module 21

3 seater
2 x back cushion XL included

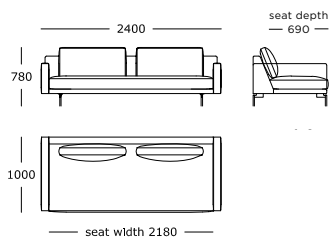

Module 22

3 seater, centre
2 x back cushion XL included

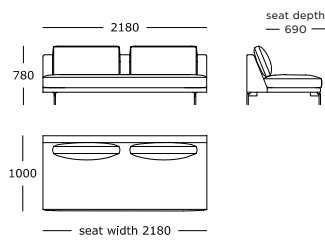

Module 23

3 seater, left arm
2 x back cushion XL included

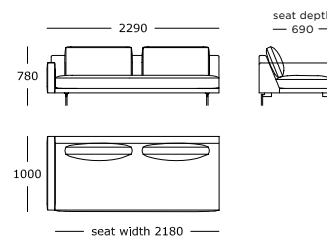

Module 24

3 seater, right arm
2 x back cushion XL included

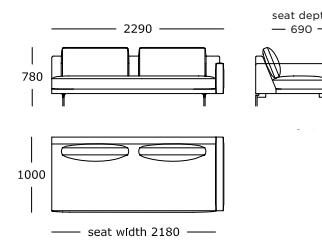

Module 25

3 seater
3 x back cushion M included

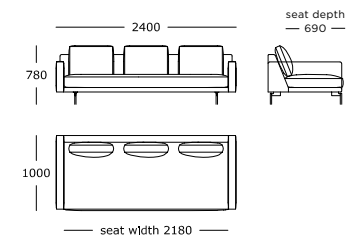

Module 26

3 seater, centre
3 x back cushion M included

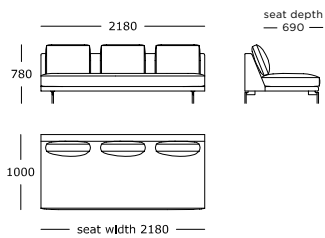

Module 27

3 seater, left arm
3 x back cushion M included

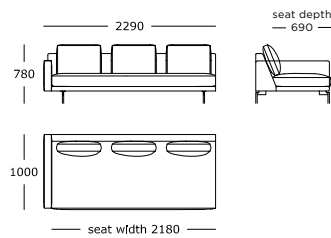

Module 28

3 seater, right arm
3 x back cushion M included

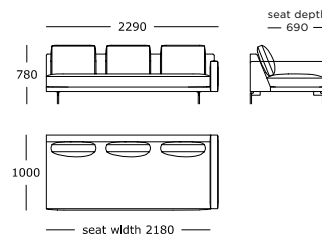

Module 29

Chaise long, left arm
1 x back cushion M included

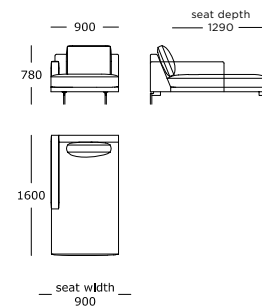

Module 30

Chaise long, right arm
1 x back cushion M included

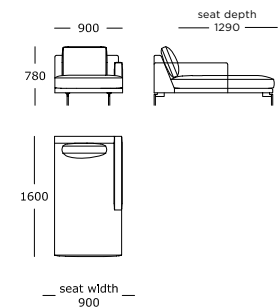

Seat height: 400 mm
Armrest height: 565 mm
Sofa depth: 1000 mm (standard) / 900 mm (optional)

Edge V2 / Module overview

Index



Fabrics



Leather



Module 31

End terminal, medium, right
2 x back cushion M + L included

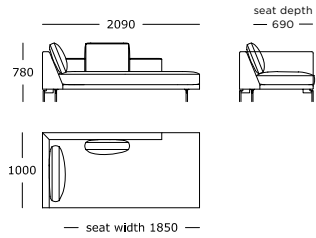

Module 32

End terminal, medium, left
2 x back cushion M + L included

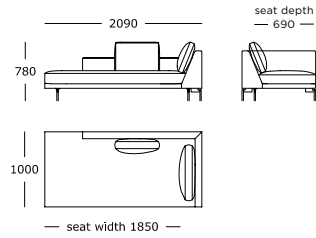

Module 33

End terminal, large, right
2 x back cushion M + L included

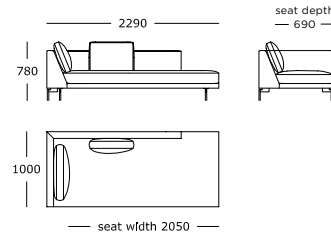

Module 34

End terminal, large, left
2 x back cushion M + L included

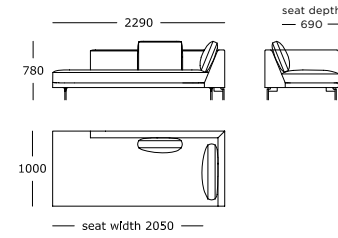

Module 35

Chair
1 x back cushion M included

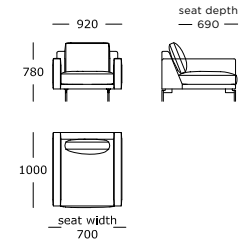

Module 36

Corner
2 x back cushion M included

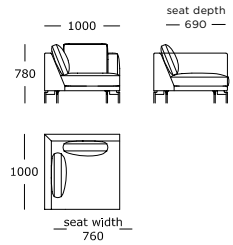

Module 37

Stool, large

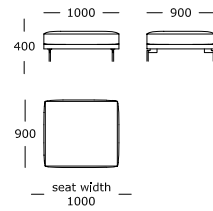

Module 38

Stool, medium

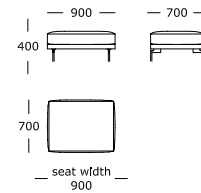

Seat height: 400 mm
Armrest height: 565 mm
Sofa depth: 1000 mm (standard) / 900 mm (optional)

Configuration 1

Modules 11 + 33

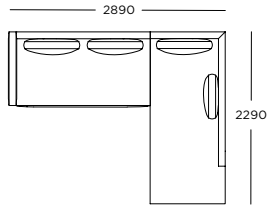

Configuration 2

Modules 29 + 12

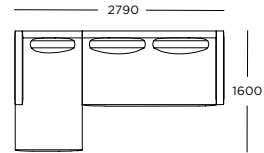

Configuration 3

Modules 27 + 36 + 28

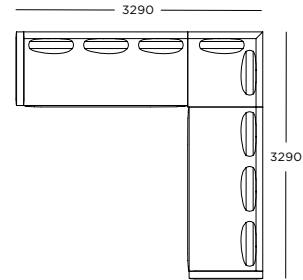

Configuration 4

Modules 34 + 26 + 33

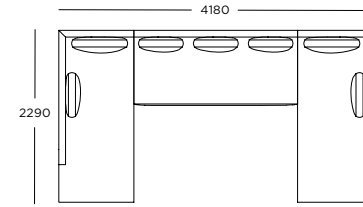

Configuration 5

Modules 3 + 2 + 30

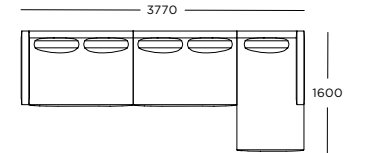

Configuration 6

Modules 29 + 2 + 33

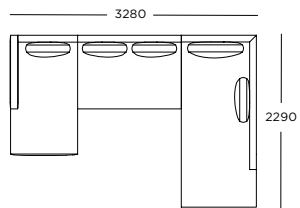

Configuration 7

Modules 32 + 4

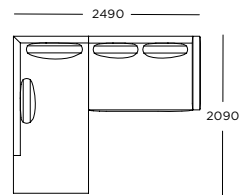



Hang / Monolithic lines

Defined by the nearly monolithic lines that make it pose as if carved in stone, the modular Hang Sofa comes with a copious form that like a paradox plays off elegantly with its slender yet strong steel frame and deep seat.

DESIGNER

Toan Nguyen

CATEGORY

Modular sofas

TEST

EN 16139

ASSEMBLY

Assembled upon receipt

LEGS

Black powder-coated steel

**STRUCTURE INTERIOR**

Frame made of solid wood and MDF with nozag spring system

STRUCTURE PADDING

High-resilient, variable density, polyurethane foam

SEAT AND BACK

High-resilient, variable density, polyurethane foam with a wrap of 100% down/feathers in a downproof cambric divided into channels

COVER

Fixed

MAINTENANCE

To ensure the longevity of your product, please follow our care and maintenance guides. All guides can be downloaded at wendelbo.com/care

WARRANTY

5 years

Module 1

2 seater

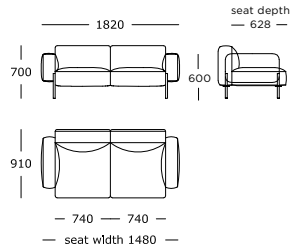

Module 2

2 seater, left arm

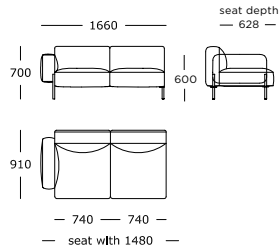

Module 3

2 seater, right arm

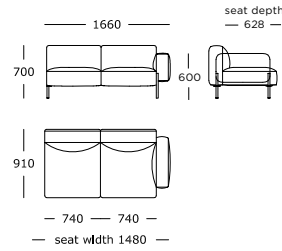

Module 4

2 seater, left corner

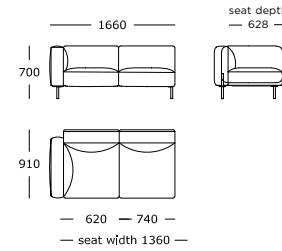

Module 5

2 seater, right corner

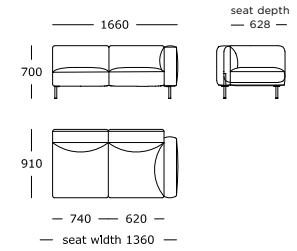

Module 6

3 seater

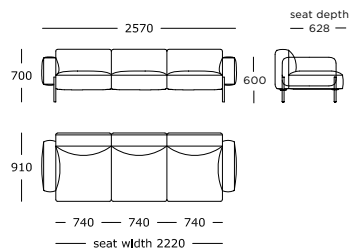

Module 7

3 seater, left arm

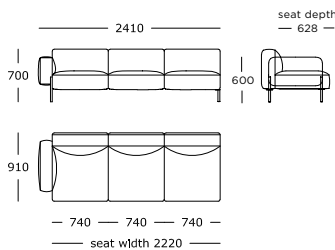

Module 8

3 seater, right arm

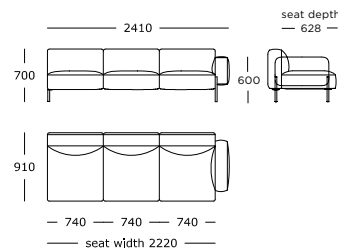

Module 9

3 seater, left corner

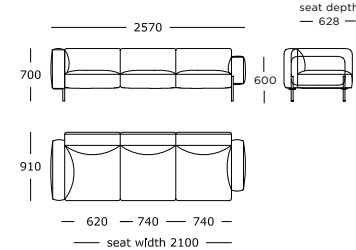

Module 10

3 seater, right corner

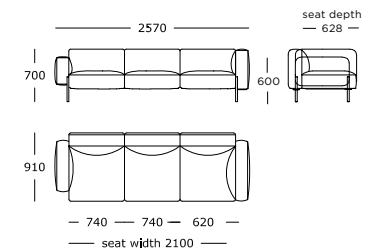

Module 11

3 seater, left corner

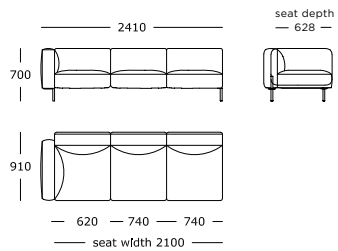

Module 12

3 seater, right corner

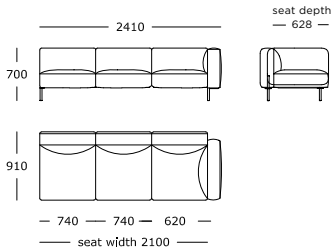

Module 13

Chaise long, left

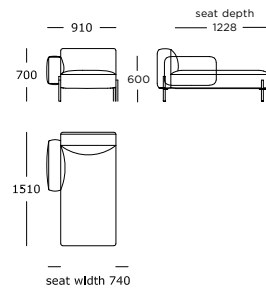

Module 14

Chaise long, right

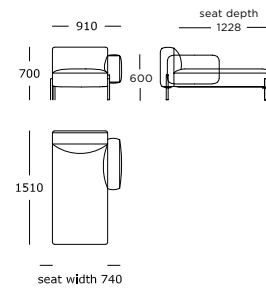

Module 15

1 seater, end terminal, left

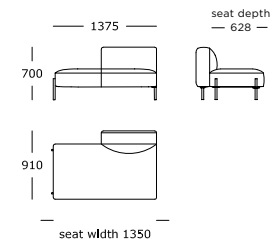

Seat height: 410 mm

Hang / Module overview

Index



Fabrics



Leather



Module 16

1 seater, end terminal, right

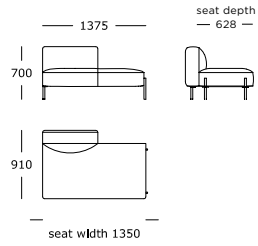

Module 17

2 seater, end terminal, left

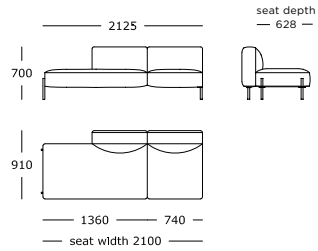

Module 18

2 seater, end terminal, right

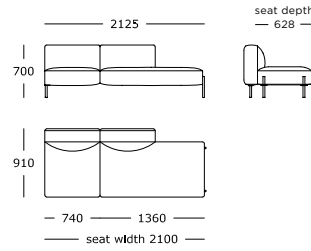

Module 19

Small stool

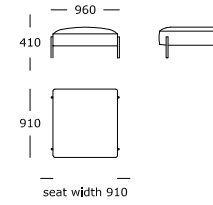

Module 20

Medium stool

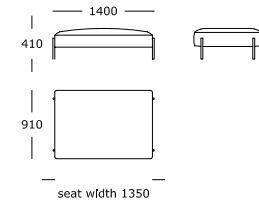

Module 21

Large stool

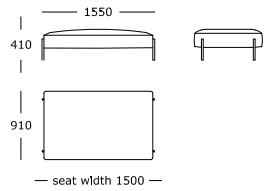

Seat height: 410 mm

Hang / Module overview

Index



Fabrics



Leather



Configuration 1

Modules 13 + 3

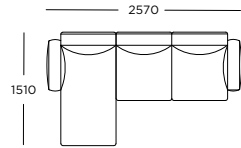

Configuration 2

Modules 15 + 3

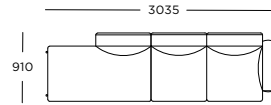

Configuration 3

Modules 15 + 4 + 16

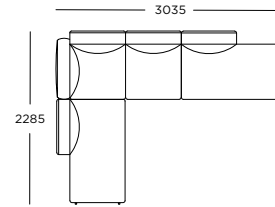

Configuration 4

Modules 15 + 14

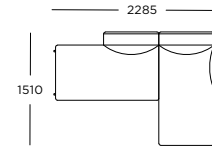

Configuration 5

Modules 9 + 7

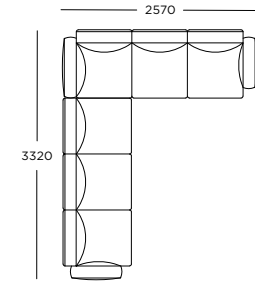



Kite /

Speaking with confidence

Opposites attract in the modular Kite design in which a sturdy and encasing exterior of upholstered panels, mimicking the planes of a kite, courts a soft, inviting inner. The result is a sofa that speaks with confidence, rather than loudly.

DESIGNER

Jonas Wagell

CATEGORY

Modular sofas

TEST

EN 16139

ASSEMBLY

Assembled upon receipt

LEGS

Black stained, dark brown stained, or light oak

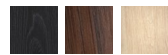

STRUCTURE INTERIOR

Frame made of solid wood, MDF and steel with webbing spring system

STRUCTURE PADDING

High-resilient, variable density, polyurethane foam with dacron padding

COVER

Removable back, seat and side cushion cover. Frame cover is fixed.

STANDARD VERSION

Seat cushion: High-resilient, variable density, polyurethane foam with 50/50 feathers and ball fibre top in a downproof cambric divided into channels

Back cushion: 50/50 feathers and ball fibre top in a downproof cambric divided into channels

CONTRACT VERSION (OPTIONAL)

Seat and back cushion: High-resilient foam with dacron padding

Same price as standard version

MAINTENANCE

To ensure the longevity of your product, please follow our care and maintenance guides. All guides can be downloaded at wendelbo.com/care

WARRANTY

5 years

Module 1

3 seater

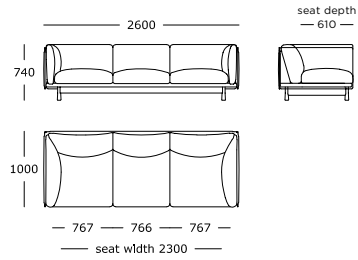

Module 2

2 seater

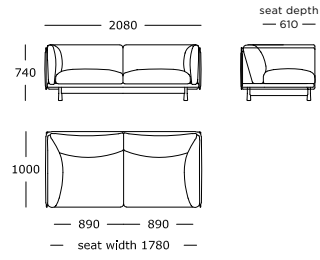

Module 3

Chair

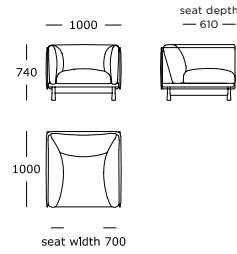

Module 4

Corner

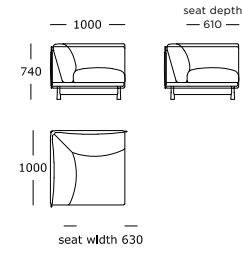

Module 5

Side module, left arm

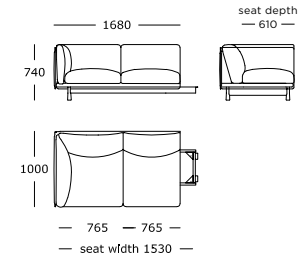

Module 6

Side module, right arm

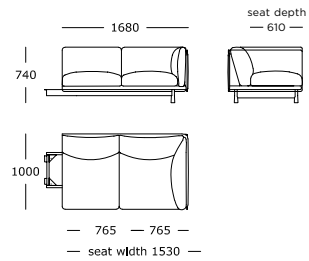

Module 7

Chaise long, left arm

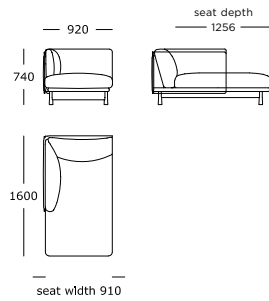

Module 8

Chaise long, right arm

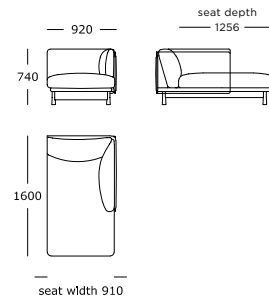

Module 9

2.5 seater

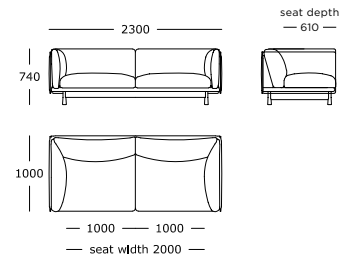

Module 10

Stool

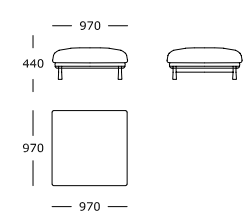

Module 11

4 seater

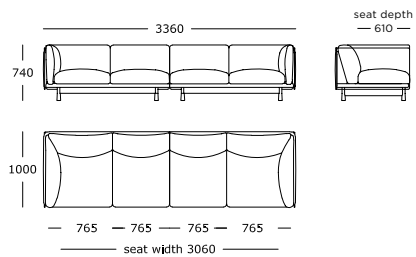

Seat height: 440 mm

Kite / Module overview

Index



Fabrics



Leather



Configuration 1

Modules 7 + 6

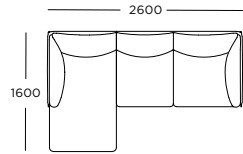

Configuration 2

Modules 5 + 4 + 6

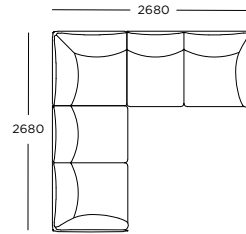



Kite High Back /

A shelter to modern spaces

The Kite High Back Sofa breathes a unique character into a known typology with its slenderly linear outline alongside a softly inviting inner. The design adds a sense of privacy and shelter to modern spaces through its soft panels that enhance the acoustics while seated in conversation.

DESIGNER

Jonas Wagell

CATEGORY

High back sofas

TEST

EN 16139

ASSEMBLY

Assembled upon receipt

LEGS

Black stained, dark brown stained, or light oak

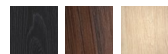

STRUCTURE INTERIOR

Frame made of solid wood, MDF and steel with webbing spring system

STRUCTURE PADDING

High-resilient, polyurethane foam

SEAT CUSHION

High-resilient, polyurethane foam with dacron padding

BACK CUSHION

High-resilient, polyurethane foam with dacron padding

COVER

Removable back and seat cushion cover. Cushion side cover is not removable

MAINTENANCE

To ensure the longevity of your product, please follow our care and maintenance guides. All guides can be downloaded at wendelbo.com/care

WARRANTY

5 years

Kite High Back

1.5 seater
2 seater

MTRS.	COM*	FABRIC								LEATHER		
		1	2	3	4	5	6	7	8	9	10	11
	11,5											
	15,0											

1.5 seater

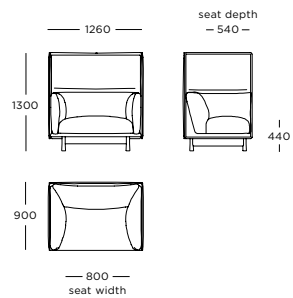

2 seater

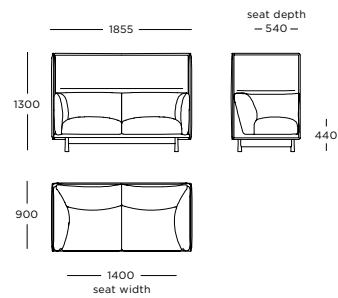

* See page 186 for additional charges



Lilin /

Retreat for relaxed communication

The Lilin Sofa has been conceived as an invitation to communication and conviviality. The soft shapes and rounded lines of the seat and backrest suggest a welcoming feeling of comfort, while the curve of its structure places those who sit in a more informal position, fostering relaxed communication.

DESIGNER

Luca Nichetto

CATEGORY

Sofas

TEST

BIFMA
EN 16139
GB

ASSEMBLY

Follow assembly instructions for mounting of legs

LEGS

Black powder-coated steel legs



STRUCTURE INTERIOR

Frame made of solid wood and MDF
with nozag spring system

STRUCTURE PADDING

High-resilient, variable density, polyurethane foam

BACK

High-resilient, variable density,
polyurethane foam

SEAT

High-resilient, variable density,
polyurethane foam

COVER

Fixed

MAINTENANCE

To ensure the longevity of your product, please follow our care and maintenance guides. All guides can be downloaded at wendelbo.com/care

WARRANTY

5 years

Lilin

2.5 seater | Curved

2 seater | Curved

3 seater | Straight

2 seater | Straight

MTRS.	COM*	FABRIC								LEATHER		
		1	2	3	4	5	6	7	8	9	10	11
6,2												
5,5												
7,2												
5,5												

2.5 seater | Curved

2 seater | Curved

3 seater | Straight

2 seater | Straight

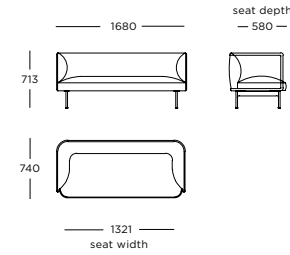
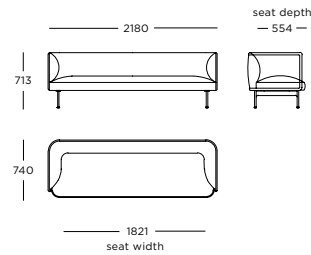
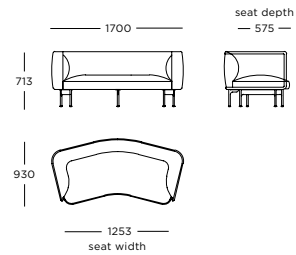
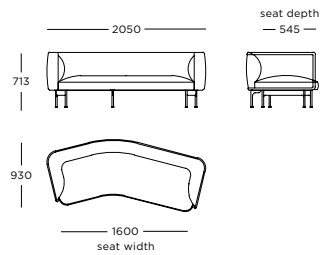

Seat height: 410 mm (standard) / 440 mm (optional)

Lilin / Price overview

Index



Fabrics



Leather





Lobby / Testaments to contemporary comfort

The Lobby Sofa and Chair add warmth to their surroundings, serving as an occasional seat with a roomy and inviting form language. Fusing together a compact size and a unique profile, the Lobby Sofa and Chair are testaments to contemporary comfort.

DESIGNER

Sarah Rousselle

CATEGORY

Sofas
Lounge chairs

TEST

BIFMA
EN 16139

ASSEMBLY

Assembled upon receipt

LEGS

Black stained wood

STRUCTURE INTERIOR

Frame made of solid wood and MDF
with nozag spring system

BACK

High-resilient, variable density,
polyurethane foam. Cover of fibre-
fill on top

SEAT

High-resilient, variable density,
polyurethane foam. Cover of fibre-
fill on top

COVER

Fixed

MAINTENANCE

To ensure the longevity of your product,
please follow our care and maintenance
guides. All guides can be downloaded at
wendelbo.com/care

WARRANTY

5 years

Lobby

Chair
2 seater

MTRS.	COM*	FABRIC								LEATHER		
		1	2	3	4	5	6	7	8	9	10	11
4,0												
5,0												

Chair

2 seater

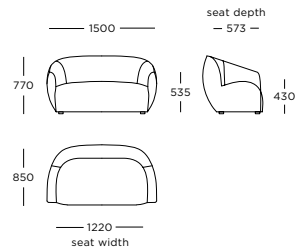
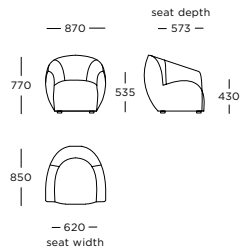

* See page 186 for additional charges



Maho / Modern manifesto

Drawn with dimensions that exude comfort, depth and modern elegance, the Maho Sofa is a study in lounging - a true retreat for days of slowing down, enhanced through loose cushions with down fill. Crafted as a voluminous low-lying lounge design, the Maho Sofa rests atop a slim and sharply defined frame in black powder-coated steel.

DESIGNER

365 North

CATEGORY

Modular sofas

TEST

EN 16139

ASSEMBLY

Follow assembly instruction for mounting of legs

LEGS

Black powder-coated steel legs



STRUCTURE INTERIOR

Frame made of solid wood and MDF with nozag spring system

STRUCTURE PADDING

High-resilient, variable density, polyurethane foam

BACK CUSHION

Back cushion 100% down/feathers

SEAT CUSHION

High-resilient, polyurethane seat cushion with a wrap of down/feathers and ball fibres in a downproof cambric divided into channels.

COVER

Loose

TRAY AND MARBLE TOP

Walnut veneer with Grey Emperador marble



Light oak veneer with Pietra Grey marble



MAINTENANCE

Loose seat- and back cushions, or filling with down and feathers, should be patted down regularly to maintain their shape. Cushions and scatters should be shaken and fluffed up regularly to maintain their shape. To ensure the longevity of your product, please follow our care and maintenance guides. All guides can be downloaded at wendelbo.com/care

WARRANTY

5 years

Module 1

2 seater, side, left arm

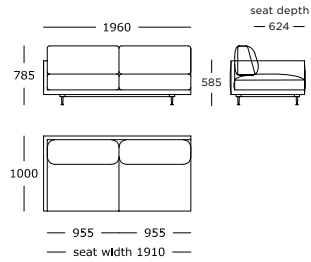

Module 2

2 seater, side, right arm

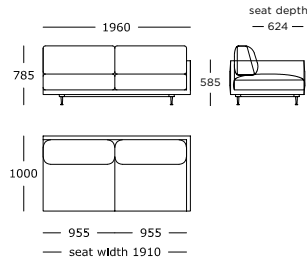

Module 3

1 seater, side, left arm

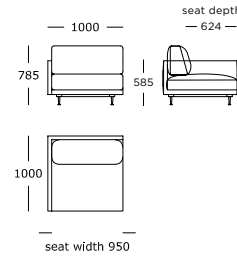

Module 4

1 seater, side, right arm

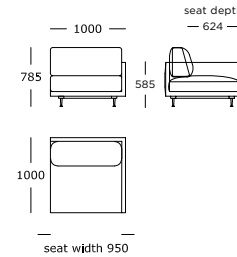

Module 5

2 seater, side/corner, left arm

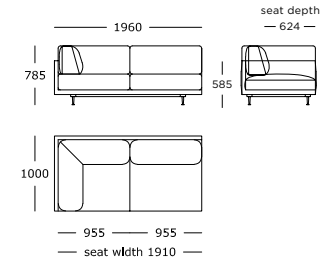

Module 6

2 seater, side/corner, right arm

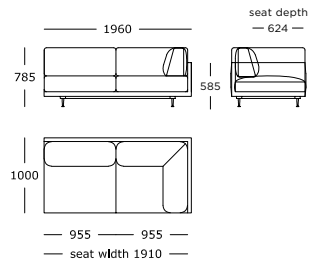

Module 7

Centre

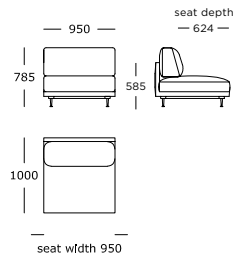

Module 8

Stool

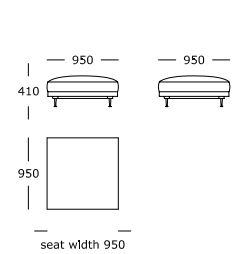

Module 9

2 seater, left arm, right tray-marble top

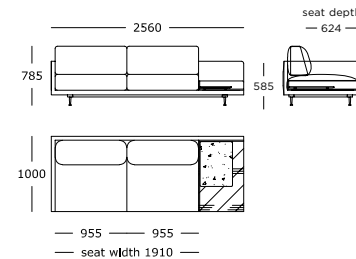

Module 10

2 seater, right arm, left tray-marble top

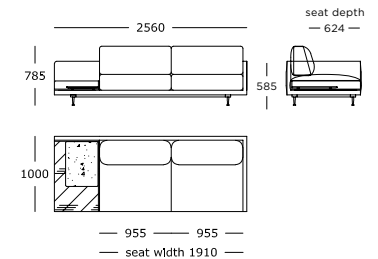

Module 11

2.5 seater, left arm, side seat cushion

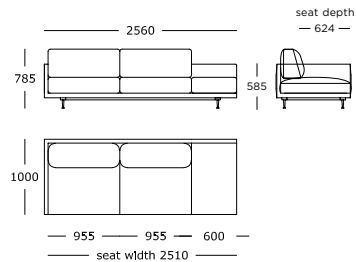

Module 12

2.5 seater, right arm, side seat cushion

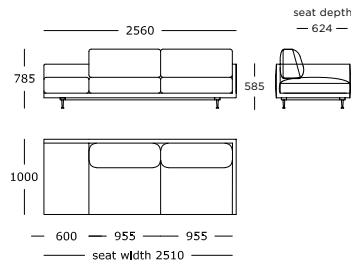

Module 13

2 seater, side/corner, left arm, tray/top

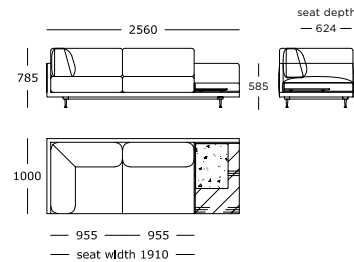

Module 14

2 seater, side/corner, right arm, tray/top

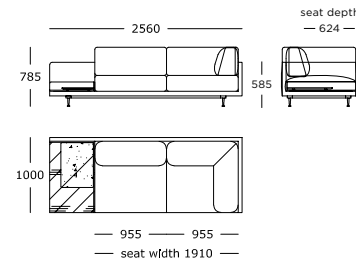

Module 15

2.5 seater, side/corner, left arm

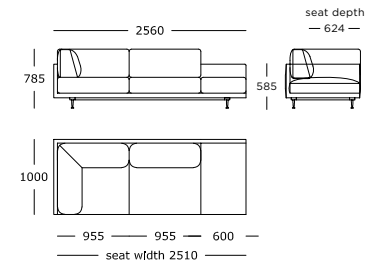

Seat height: 410 mm (standard) / 440 mm (optional)

Maho / Module overview

Index



Fabrics



Leather



Module 16

2.5 seater, side/corner, right arm

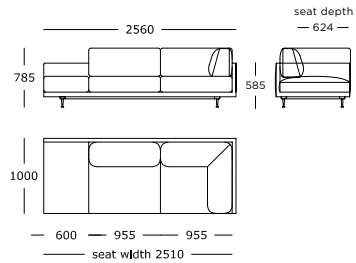

Module 17

1 seater, wooden tray/marble top

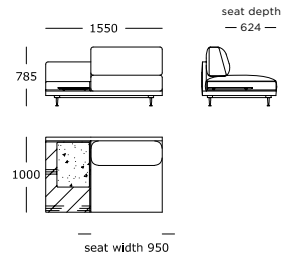

Module 18

1 seater, wooden tray/marble top

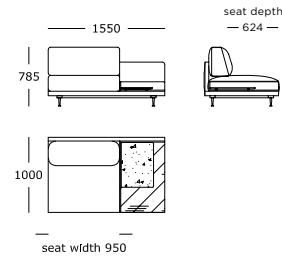

Module 19

1.5 seater, side seat cushion

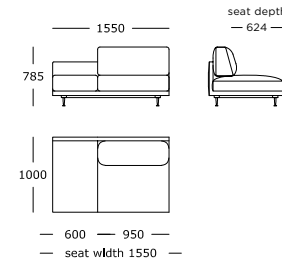

Module 20

1.5 seater, side seat cushion

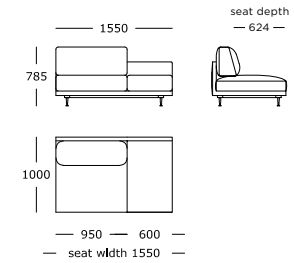

Module 21

1 seater, wooden tray/marble top, right arm

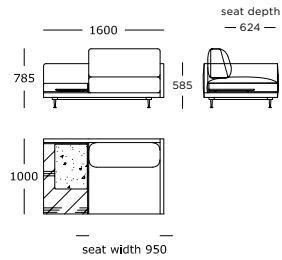

Module 22

1.5 seater, wooden tray/marble top, left arm

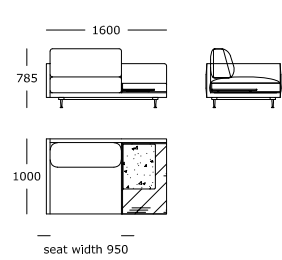

Module 23

1.5 seater, side seat cushion, right arm

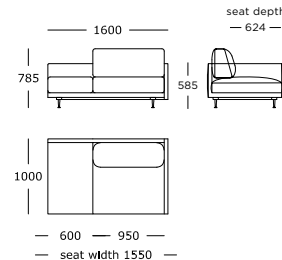

Module 24

1.5 seater, side seat cushion, left arm

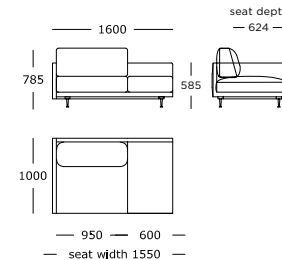

Module 25

Chaise long, left arm

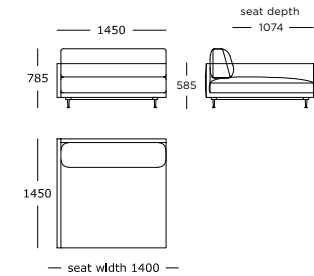

Module 26

Chaise long, right arm

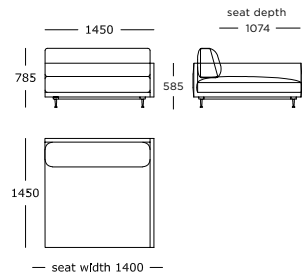

Module 27

Corner

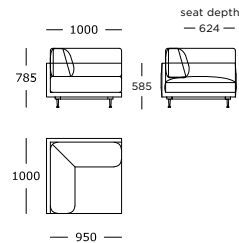

Module 28

One sided long, open left end

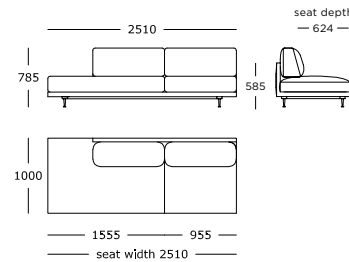

Module 29

One sided long, open right end

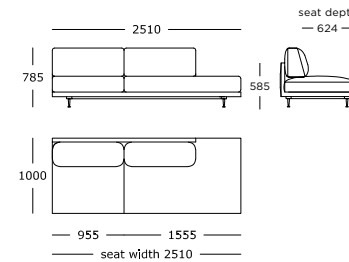

Module 30

Corner side long, open right arm

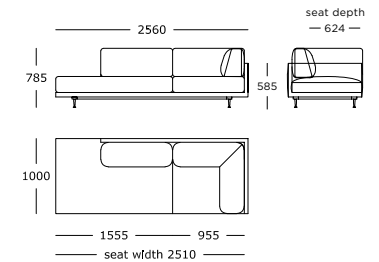

Seat height: 410 mm (standard) / 440 mm (optional)

Maho / Module overview

Index



Fabrics



Leather



Module 31

2.5 seater, side/corner, right arm

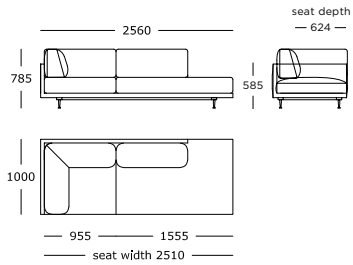

Module 32

Chaise, left arm

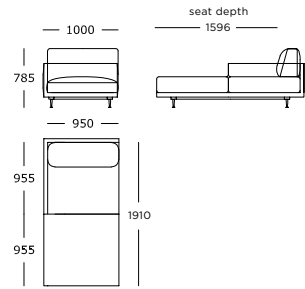

Module 33

Chaise, right arm

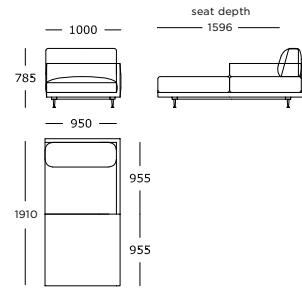

Module 34

Chaise, no arms

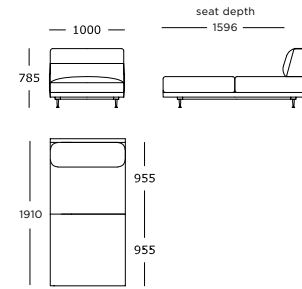

Module 35

3 seater, corner cushion left

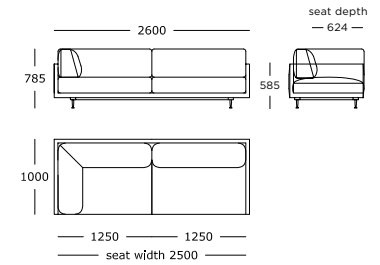

Module 36

3 seater, corner cushion right

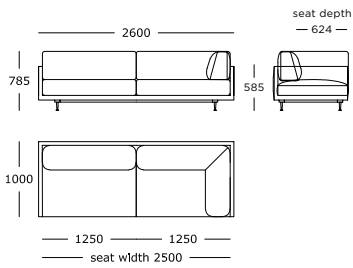

Module 37

3 seater

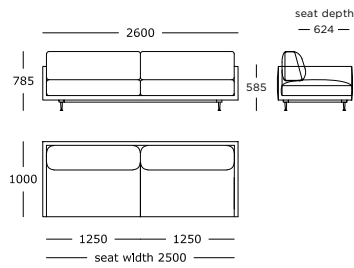

Module 38

2.5 seater, corner cushion left

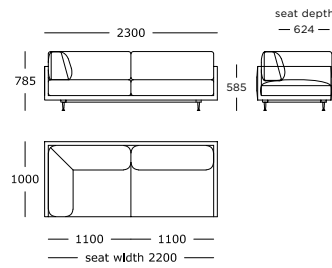

Module 39

2.5 seater, corner cushion right

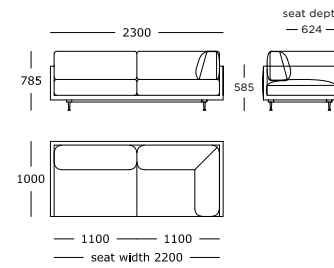

Module 40

2.5 seater

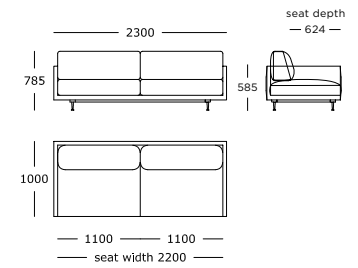

Module 41

2 seater, corner cushion left

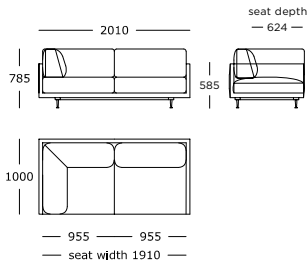

Module 42

2 seater, corner cushion right

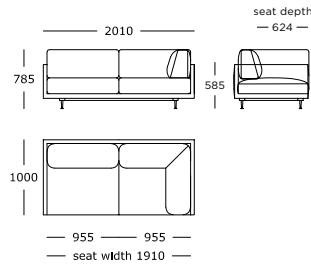

Module 43

2 seater

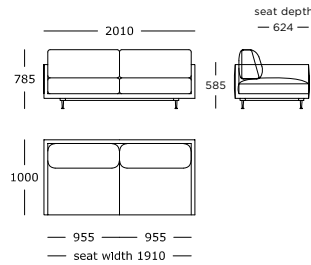

Seat height: 410 mm (standard) / 440 mm (optional)

Maho / Module overview

Index



Fabrics



Leather



Configuration 1

Modules 25 + 10

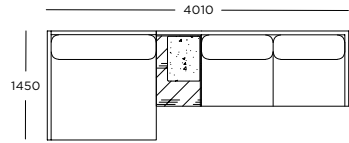

Configuration 2

Modules 1 + 31

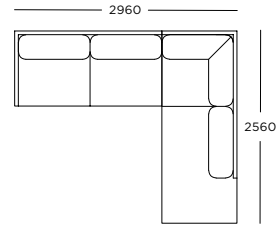

Configuration 3

Modules 1 + 33

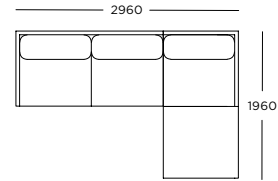

Configuration 4

Modules 28 + 31

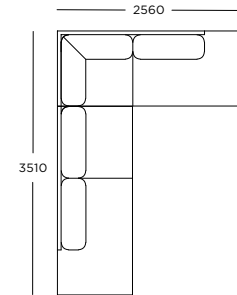

Configuration 5

Modules 1 + 14 + 2

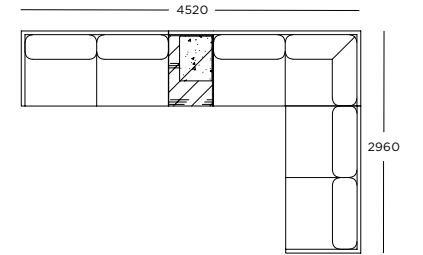

Configuration 7

Modules 28 + 26

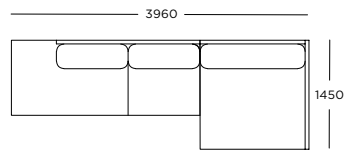

Configuration 8

Modules 3 + 29

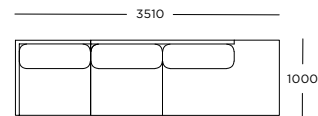

Configuration 9

Modules 14 + 7 + 2

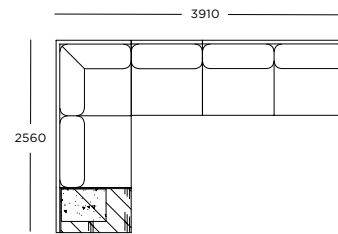

Configuration 10

Modules 25 + 2

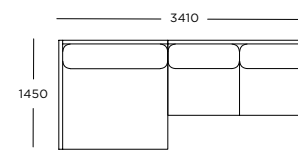



Montholon /

Elegance in motion

The Montholon collection blends generous proportions with an airy lightness, achieved through a recessed base that subtly lifts the design from the floor. The gracefully curved silhouette accentuates the freestanding qualities of the design, offering an elegant presence from every perspective.

DESIGNER

Tristan Lohner

CATEGORY

Sofas
Lounge chairs

ASSEMBLY

Assembled upon receipt

BASE

Black stained solid oak

LOUNGE CHAIR BASE

Black stained solid oak
Swivel with 180° return

STRUCTURE INTERIOR

Solid wood and plywood

STRUCTURE PADDING

High-resilient, polyurethane foam

SEAT

High-resilient, variable density,
polyurethane foam

BACK

High-resilient, variable density,
polyurethane foam with dacron
padding

COVER

Fixed

MAINTENANCE

To ensure the longevity of your product, please follow our care and maintenance guides. All guides can be downloaded at wendelbo.com/care

WARRANTY

5 years

Montholon

	MTRS.	FABRIC								LEATHER		
		COM*	1	2	3	4	5	6	7	8	9	10
Sofa 3 seater	10,6											
Sofa 3 seater, curved	11,0											
Sofa 2.5 seater	9,8											
Chair Swivel with 180° return	5,0											
Scatter cushion 50 x 50	0,6											
Scatter cushion 55 x 55	0,7											

3 seater | 2 sections

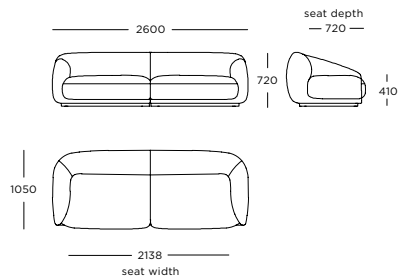

3 seater | Curved / 2 sections

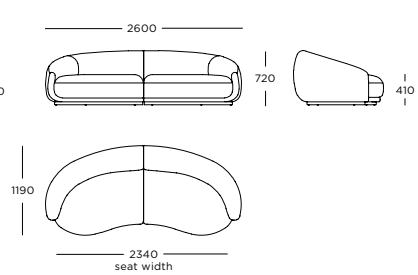

2.5 seater | 2 sections

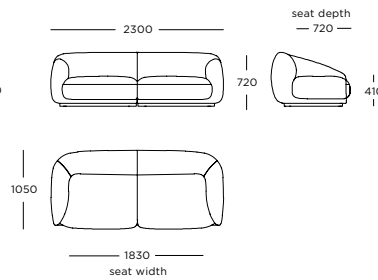

Chair | Swivel with return

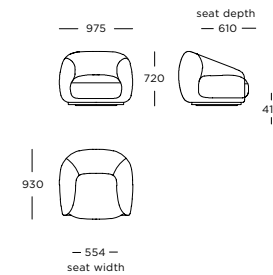

* See page 186 for additional charges



Nova /

When comfort plays protagonist

The Nova Sofa boasts a no-nonsense aesthetic, distilling the well-known typology down to its very essence - leaving behind incomparable comfort, ensured by soft side and back cushions. Available in three versions with several leg options, the design can be customised to match any spatial setting.

DESIGNER

Lars Wendelbo

CATEGORY

Sofas
Modular sofas

TEST

EN 16139

ASSEMBLY

Follow assembly instructions for mounting of legs

LEGS

Stainless steel
Aluminium
Black aluminium
Light oak
Black stained oak



STRUCTURE INTERIOR

Frame made of solid wood and MDF with nozag spring system

STRUCTURE PADDING

High-resilient, variable density, polyurethane foam with dacron padding

SEAT CUSHION

High-resilient, variable density, polyurethane foam with soft wrap

Optional (with surcharge):
Reversible down top

BACK CUSHION

50/50 feathers and ball fibres top in downproof cambric divided into channels

COVER

Choose between fixed and loose

MAINTENANCE

Loose seat- and back cushions, or filling with down and feathers, should be patted down regularly to maintain their shape. Cushions and scatters should be shaken and fluffed up regularly to maintain their shape. To ensure the longevity of your product, please follow our care and maintenance guides. All guides can be downloaded at wendelbo.com/care

WARRANTY

5 years

Nova V1

3 seater, 3 sections
Arm cushions included

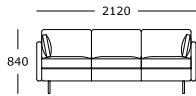

3 seater, 2 sections
Arm cushions included

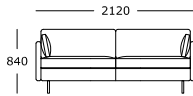

2.5 seater, 2 sections
Arm cushions included

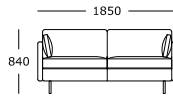

2 seater, 2 sections
Arm cushions included

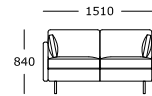

Chair

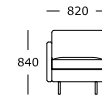

Stool

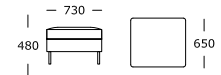

Nova V2

3 seater, 3 sections
Arm cushions included

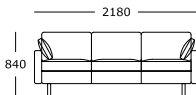

3 seater, 2 sections
Arm cushions included

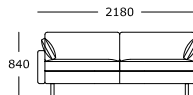

2.5 seater, 2 sections
Arm cushions included

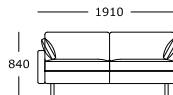

2 seater, 2 sections
Arm cushions included

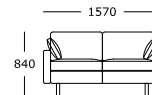

Chair

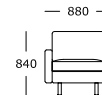

Stool

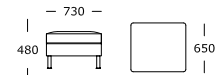

Nova V3

3 seater, 3 sections
Arm cushions included

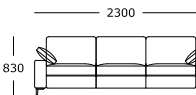

3 seater, 2 sections
Arm cushions included

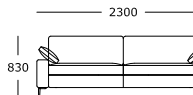

2.5 seater, 2 sections
Arm cushions included

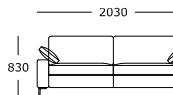

2 seater, 2 sections
Arm cushions included

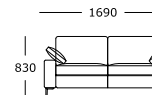

Chair

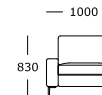

Stool

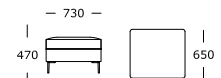

Depth: 880 mm (standard) / 830 mm (optional)

Nova V1 - V3 / Module overview

Index



Fabrics



Leather



Module 1

1 seater, medium

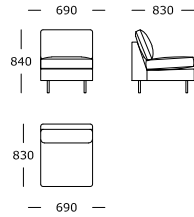

Module 2

2 seater, medium

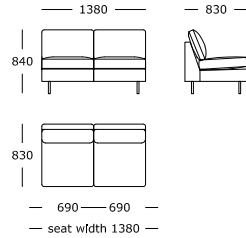

Module 3

2.5 seater, medium

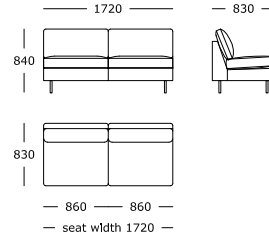

Module 4

3 seater, medium
2 or 3 cushions

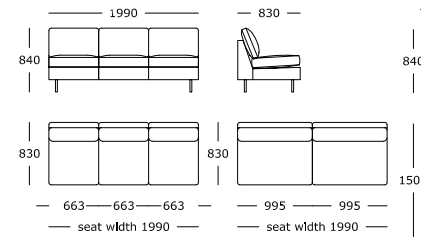

Module 5

Chaise long

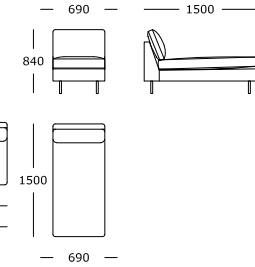

Module 6

Corner, medium

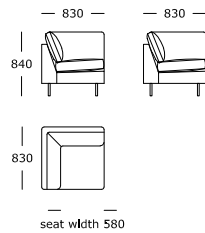

Module 9

Chaise long

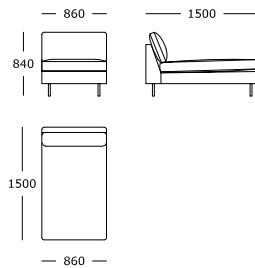

Module 10

1 seater, large

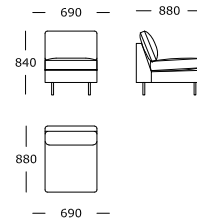

Module 11

2 seater, large

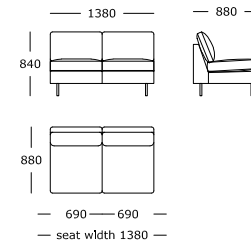

Module 12

2.5 seater, large

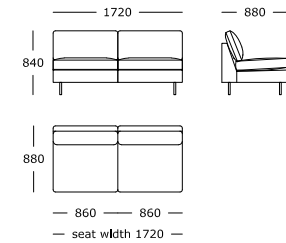

Module 13

3 seater, large
2 or 3 cushions

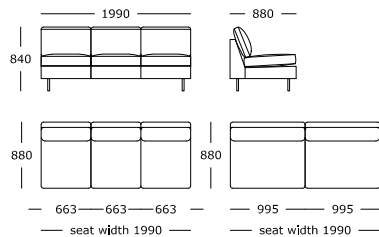

Module 14

Stool

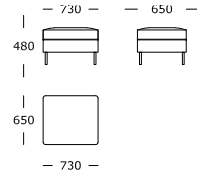

Module 15

Corner, large

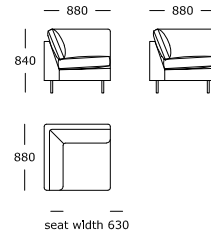

Module 18

Set of arms - V1
Arm cushions included



Module 19

Set of arms - V2
Arm cushions included



Module 20

Set of arms - V3
Arm cushions included



Seat height: 480 mm



Nova

- 3 seater**
- 2.5 seater**
- 2 seater**
- Chair**
- Chaise long**
- Corner**
- Stool**

ADDITIONAL

PRICE

- Reversible down top
- Reversible down top
- Reversible down top
- Reversible down top
- Reversible down top
- Reversible down top
- Reversible down top



Black oak / Light oak



Stainless steel



Stainless steel



**Aluminium /
Black aluminium**

**Legs
Standard**

Nova V1

Nova V2

Nova V3

Alternatives

Nova V1
Nova V2
Nova V3

Nova V2
Nova V3

Nova V1
Nova V3

Nova / Additional

Index



Fabrics



Leather





Panorama / Shaped with simplified volumes

The modular Panorama Sofa is shaped with simplified volumes and repeated proportions, resulting in an organic fit for any space, be it modest or grand. With its curved, embracing back, the sofa pulls the user intuitively into the deep, comfortable seat modules, fully upholstered to the ground.

DESIGNER

Jonas Wagell

CATEGORY

Modular sofas

TEST

EN 16139

GB

ASSEMBLY

Assembled upon receipt

LEGS

Black stained solid oak

STRUCTURE INTERIOR

Frame made of solid wood and MDF with webbing spring system

STRUCTURE PADDING

High-resilient, variable density, polyurethane foam with dacron padding

SEAT

High-resilient, variable density, polyurethane foam with dacron padding

BACK

High-resilient, variable density, polyurethane foam with dacron padding

COVER

Fixed

POWER PLUG

Price on request

MAINTENANCE

To ensure the longevity of your product, please follow our care and maintenance guides. All guides can be downloaded at wendelbo.com/care

WARRANTY

5 years

Module 1

1 seater, side left

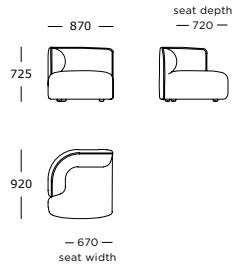

Module 2

1 seater, side right

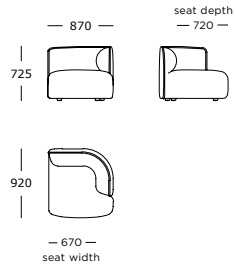

Module 3

1 seater, centre

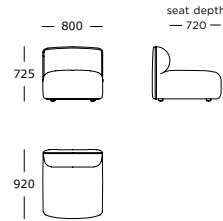

Module 4

Large 1 seater, side left

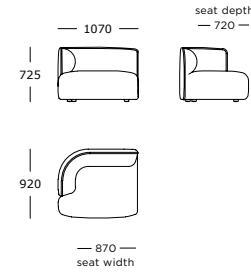

Module 5

Large 1 seater, side right

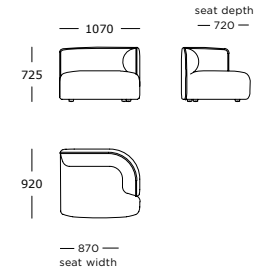

Module 6

1.5 seater, centre

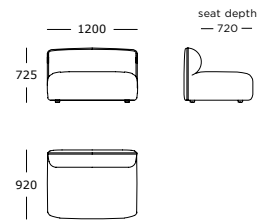

Module 7

1.5 seater, open end right

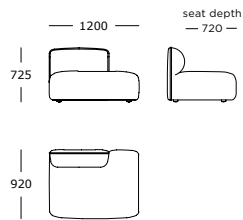

Module 8

1.5 seater, open end left

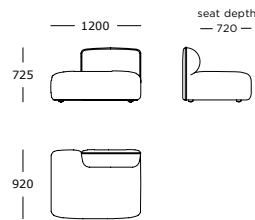

Module 9

1 seater, centre
Curved front and straight back

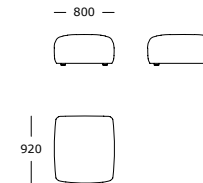

Module 10

Chaise long, left

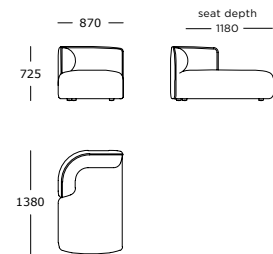

Module 11

Chaise long, right

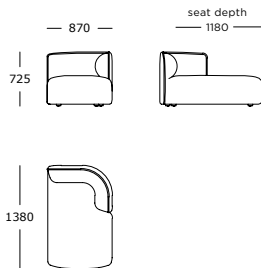

Module 12

Corner, 90 degree

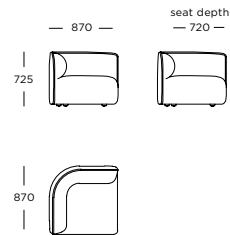

Module 13

Corner, 60 degree

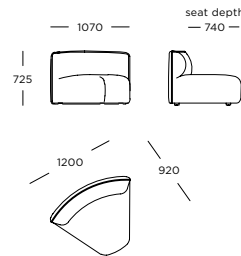

Module 14

Small pouf

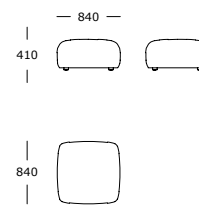

Module 15

Large pouf

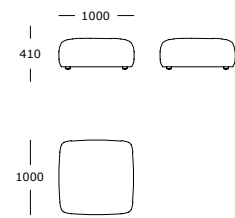

Seat height: 410 mm

Panorama / Module overview

Index



Fabrics



Leather



Module 16

Corner, 60 degree, no back

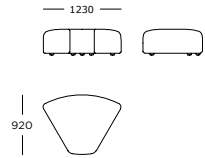

Module 17

1 seater, centre
Curved front and back

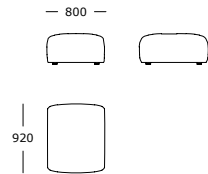

Module 18

Corner, 60 degree
Narrow back

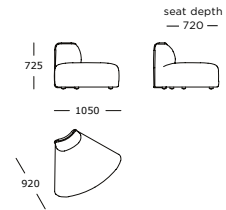

Seat height: 410 mm



Configuration 1

Modules 1 + 3 + 7

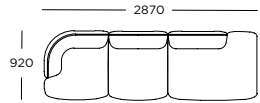

Configuration 2

Modules 4 + 6 + 11

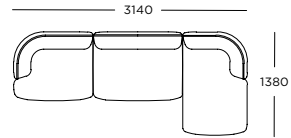

Configuration 3

Modules 13 + 13 + 3 + 3 + 13 + 13

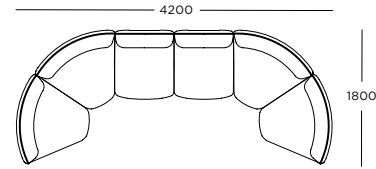

Configuration 4

Modules 8 + 13 + 3 + 7

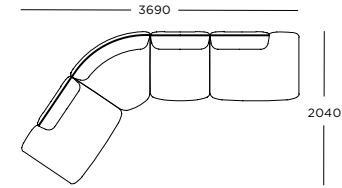

Configuration 5

Modules 8 + 13 + 2

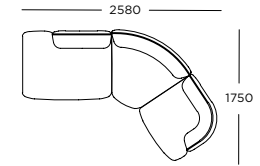

Configuration 6

Modules 12 + 3 + 7 + 8 + 3 + 12 + 7

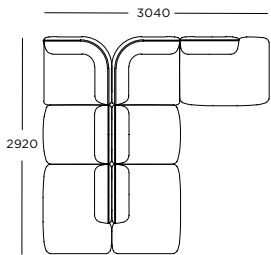

Configuration 7

Modules 6 x 16 + 6 + 6

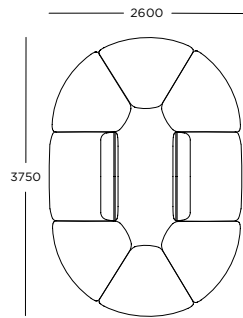

Configuration 8

Modules 16 + 16 + 17 + 16 + 16

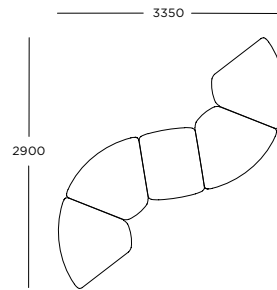

Configuration 9

Modules 8 + 13 + 3 + 13 + 6 + 13 + 3 + 13 + 3 + 13

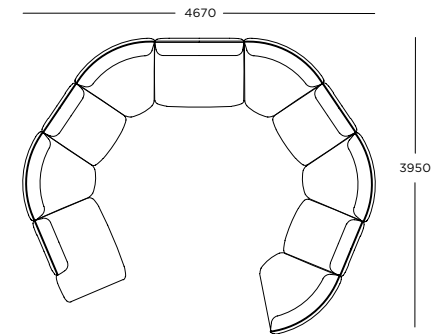



Panorama Dine /

Sequences of creative seating

Guided by the distinctive design language, Jonas Wagell has reiterated the Panorama concept into a comprehensive Dine collection, featuring a modular banquette-style sofa, compact chair, pouf and table. Facilitating the design of creative seating sequences, the collection demonstrates its adaptability across diverse commercial environments.

DESIGNER

Jonas Wagell

CATEGORY

Modular sofas
Chairs
Tables

TEST

BIFMA

ASSEMBLY

Assembled upon receipt
Follow assembly instructions
for mounting of table

LEGS

Black stained solid oak

STRUCTURE INTERIOR

Frame made of solid wood and MDF
with webbing spring system

STRUCTURE PADDING

High-resilient, variable density, polyurethane foam with dacron padding

SEAT AND BACK

High-resilient, variable density, polyurethane foam with dacron padding

COVER

Fixed

POWER PLUG

Price on request

TABLE BASE

Black powder-coated steel



TABLE TOP

Black stained oak veneer
Linoleum col. Iron

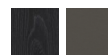

Border in black stained solid oak

MAINTENANCE

To ensure the longevity of your product, please follow our care and maintenance guides. All guides can be downloaded at wendelbo.com/care

WARRANTY

5 years

Module 1

1 seater, side left

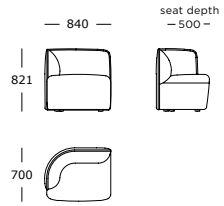

Module 2

1 seater, side right

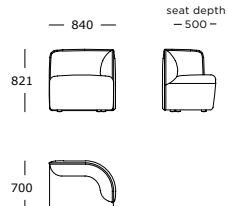

Module 3

1 seater, centre

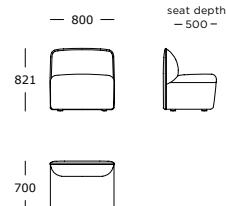

Module 4

1.5 seater, centre

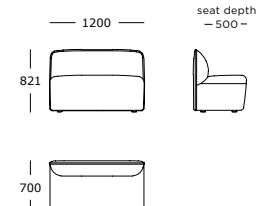

Module 5

2 seater, centre

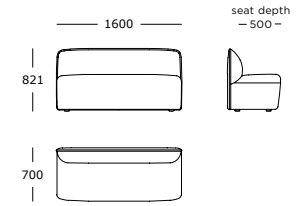

Module 6

1.5 seater, left arm

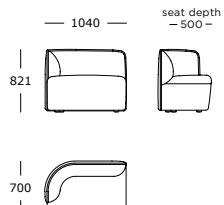

Module 7

1.5 seater, right arm

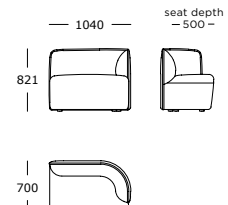

Module 8

Corner, 90 degree

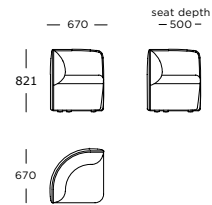

Module 9

Corner, 60 degree

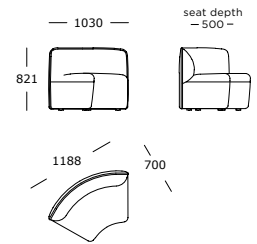

Module 10

Corner, 30 degree

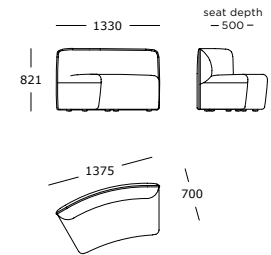

Module 11

1 seater, no back

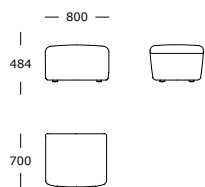

Compact chair

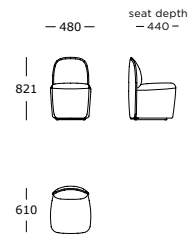

Compact pouf

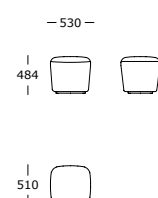

Table

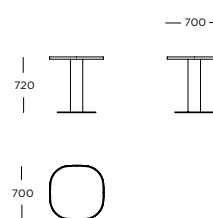

Seat height: 484 mm

Panorama Dine / Module overview

Index



Fabrics



Leather



Configuration 1

Modules 1 + 4 + 2

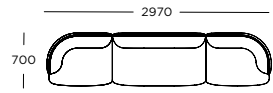

Configuration 2

Modules 1 + 9 + 2

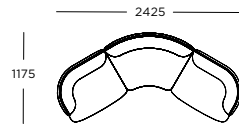

Configuration 3

Modules 2 + 10 + 4

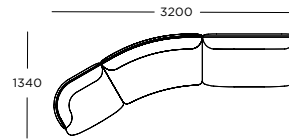

Configuration 4

Modules 4 + 9 + 7

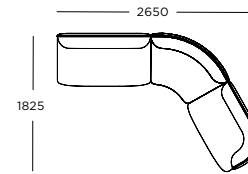

Configuration 5

Modules 1 + 9 + 10 + 2

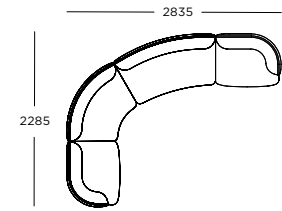

Configuration 6

Modules 5 + 5 + 5 + 5

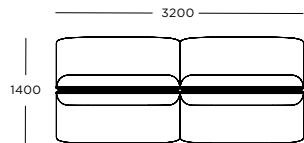

Configuration 7

Modules 5 + 8 + 5 + 8 + 5

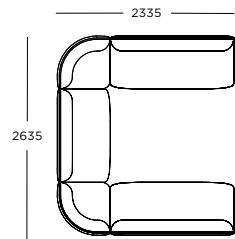

Configuration 8

Modules 3 + 9 + 9 + 9 + 3

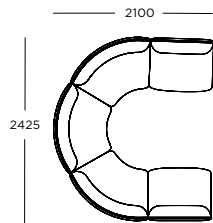

Configuration 9

Modules 6 + 9 + 10 + 9 + 7

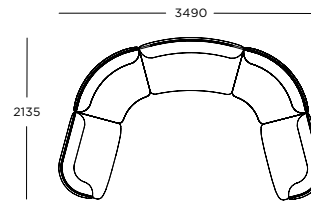



Pontone / Speaking in volumes

The Pontone Sofa is one that speaks volumes without making much visual noise, communicated through the folded details of its armrest, its pointy shapes, and the lines of its loose cushions. Elevated by recessed legs in black stained oak, the modular design can be further modified with back and lumbar cushions.

DESIGNER

365 North

CATEGORY

Modular sofas

TEST

EN 16139

ASSEMBLY

Assembled upon receipt

LEGS

Black stained solid wood

STRUCTURE INTERIOR

Frame made of solid wood and MDF with nozag spring system

SEAT

High-resilient, variable density, polyurethane foam with a cover of down/feathers and ball fibres in a downproof cambric divided into channels

BACK

Down/feathers and ball fibres in a downproof cambric divided into channels

BACK CUSHION

100% down/feathers

COVER

Loose

MAINTENANCE

Loose seat- and back cushions, or filling with down and feathers, should be patted down regularly to maintain their shape. Cushions and scatters should be shaken and fluffed up regularly to maintain their shape. To ensure the longevity of your product, please follow our care and maintenance guides. All guides can be downloaded at wendelbo.com/care

WARRANTY

5 years

Module 1

Small, high arm, left XL

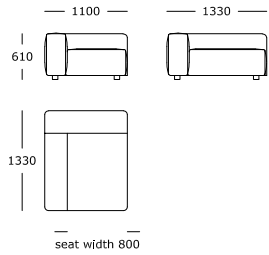

Module 2

Small, high arm, right XL

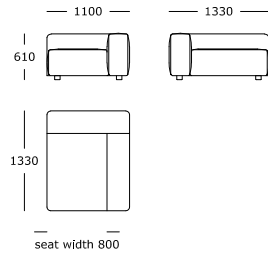

Module 3

Small, low arm, left L

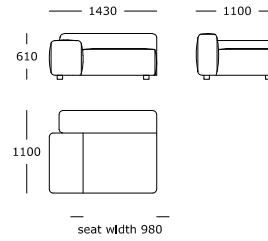

Module 4

Small, low arm, right L

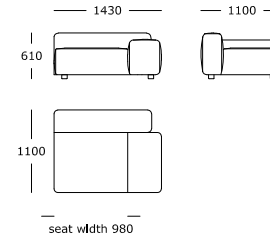

Module 5

Medium, high arm, left XL

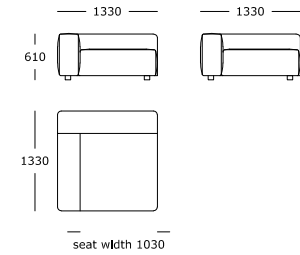

Module 6

Medium, high arm, right XL

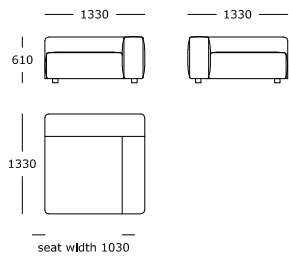

Module 7

Medium, low arm, left L

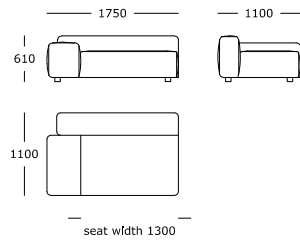

Module 8

Medium, low arm, right L

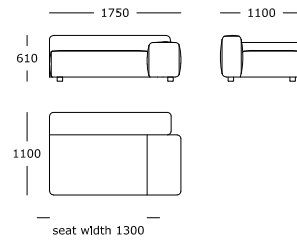

Module 9

Medium, high arm, left L

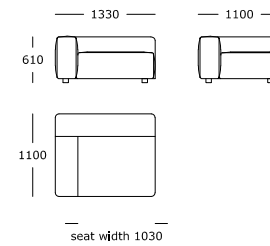

Module 10

Medium, high arm, right L

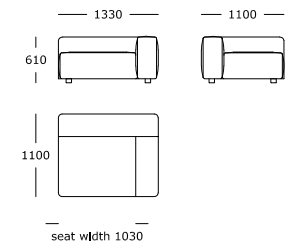

Module 11

Large, high arm, left L

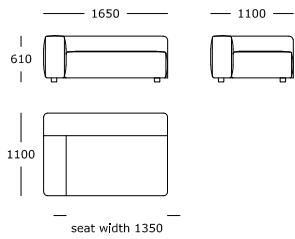

Module 12

Large, high arm, right L

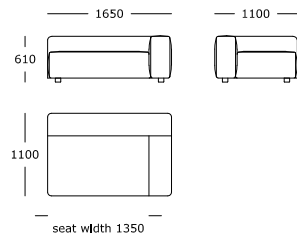

Module 13

Terminal, high arm, left

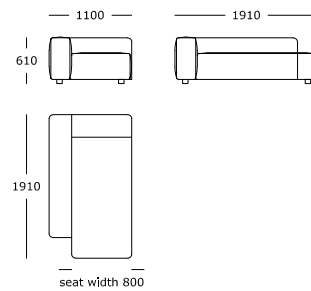

Module 14

Terminal, high arm, right

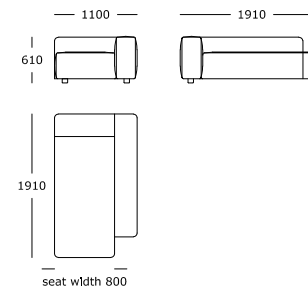

Module 15

Centre, XL

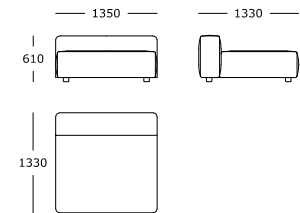

Seat height: 410 mm
Back cushions are not included

Pontone / Module overview

Index



Fabrics



Leather



Module 16

Centre

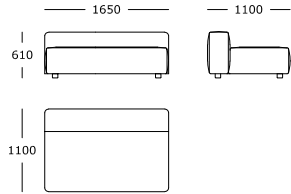

Module 17

Terminal, low arm, left

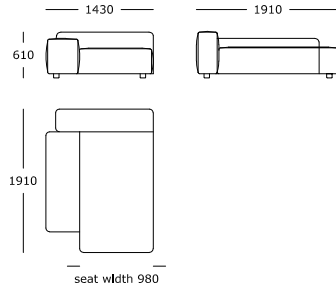

Module 18

Terminal, low arm, right

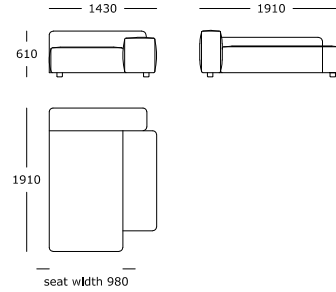

Module 19

Side/corner module left

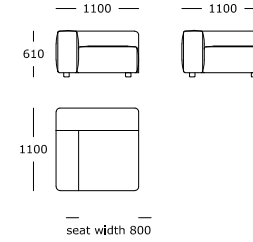

Module 20

Centre

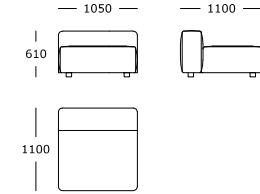

Module 21

Side/corner module right

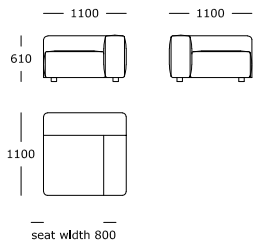

High arm

Low arm



Seat height: 410 mm
Back cushions are not included



Configuration 1

Modules 5 + 8

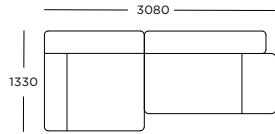

Configuration 2

Modules 7 + 18

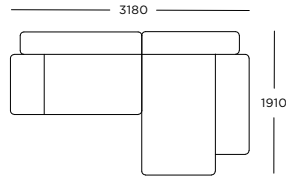

Configuration 3

Modules 7 + 8

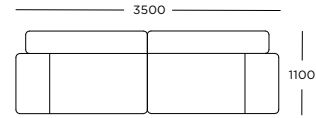

Configuration 4

Modules 11 + 21 + 12

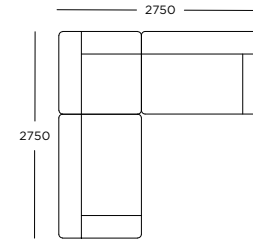

Configuration 5

Modules 17 + 16

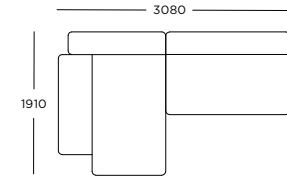

Configuration 6

Modules 17 + 20 + 20

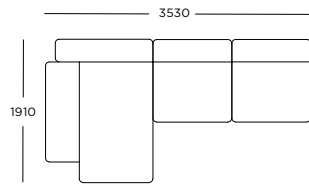

Configuration 7

Modules 13 + 20 + 10

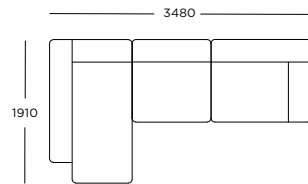

Configuration 8

Modules 11 + 20 + 12

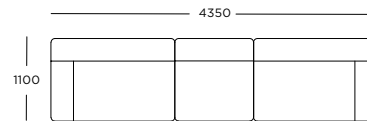



Rest /

Natural breathing space

When looking for a place to zone out for a while, get some work done, recharge ahead of a meeting or anything in-between: Look for the flowing lines of the Rest Bench. Bended, upholstered elements have been pieced together in an elegant harmony, offering a natural breathing space.

DESIGNER

Sebastian Herkner

CATEGORY

Benches

TEST

BIFMA
EN 16139

ASSEMBLY

Assembled upon receipt
Follow assembly instructions
for mounting of table

LEGS

Black rubber gliders

STRUCTURE INTERIOR

Frame made of solid wood, steel
and MDF

STRUCTURE PADDING

High-resilient, variable density, polyurethane foam with dacron padding

SEAT

High-resilient, variable density, polyurethane foam with dacron padding

COVER

Fixed

TABLE

Black powder-coated steel

**MAINTENANCE**

To ensure the longevity of your product, please follow our care and maintenance guides. All guides can be downloaded at wendelbo.com/care. For maintenance of table, clean with damp cloth.

WARRANTY

5 years

1.5 seater | Left side

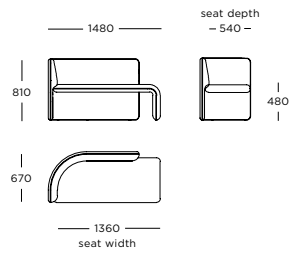

1.5 seater | Right side

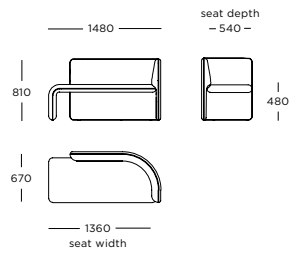

1 seater | Left side

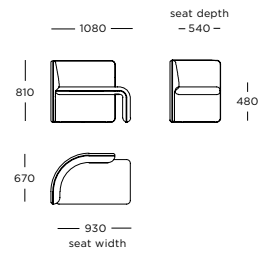

1 seater | Right side

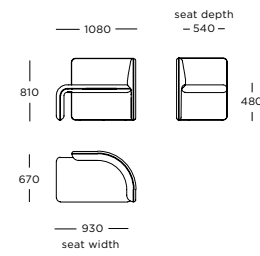

Mounted table | Ø30

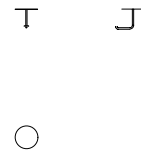
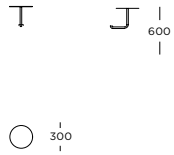



Sepal /

A deceptively simple design

Though deceptively simple in its design, the Sepal series features a wealth of details. From the fine, lightweight frame in black powder-coated steel to the precision-made tailoring of the upholstered interior. Lending its name from botany, just like the sepals on a frail flower, the series upholds a sturdy yet delicate character.

DESIGNER

Luca Nichetto

CATEGORY

Lounge chairs
Sofas
Dining chairs

TEST

BIFMA
EN 16139
GB

ASSEMBLY

Assembled upon receipt

LEGS

Black powder-coated steel



STRUCTURE INTERIOR

Frame made of solid wood and MDF with elastic webbing and high-density foam profiles on top

STRUCTURE PADDING

High-resilient, variable density, polyurethane foam

BACK

High-resilient, variable density, polyurethane foam. Wrap of fibre-fill on top

SEAT

High-resilient, variable density, polyurethane foam. Wrap of fibre-fill on top

COVER

Fixed

GLIDES

Wagner QuickClick
Standard: Plastic
Optional: Felt

MAINTENANCE

To ensure the longevity of your product, please follow our care and maintenance guides. All guides can be downloaded at wendelbo.com/care

WARRANTY

5 years



Surface / Dynamic seating landscape

Designed with complementary trays in black stained or light oak, the Surface Sofa prompts a new take on modularity with engaging levels and dimensions that speak volumes in any spatial context. Thin legs in black powder-coated aluminium add the finishing touches, making the modules soar gracefully above the ground.

DESIGNER

365 North

CATEGORY

Sofas
Modular sofas

TEST

EN 16139
GB

ASSEMBLY

Follow assembly instructions for mounting of legs

LEGS

Black powder-coated aluminium



STRUCTURE INTERIOR

Frame made of solid wood and MDF with nozag spring system

STRUCTURE PADDING

High-resilient, variable density, polyurethane foam with dacron padding

SEAT CUSHION

High-resilient polyurethane foam with 100% down/feathers top in downproof cambric divided into channels

BACK CUSHION

100% down/feathers top in downproof cambric divided into channels

COVER

Removable back and seat cushions

WOODEN TRAY

Black stained oak
Light oak



MAINTENANCE

Loose seat- and back cushions, or filling with down and feathers, should be patted down regularly to maintain their shape. Cushions and scatters should be shaken and fluffed up regularly to maintain their shape. To ensure the longevity of your product, please follow our care and maintenance guides. All guides can be downloaded at wendelbo.com/care

WARRANTY

5 years

Module 1

2 seater, narrow left arm

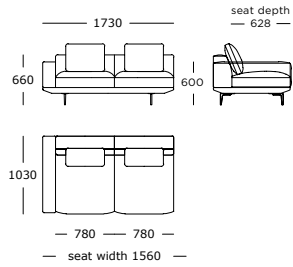

Module 2

2 seater, narrow right arm

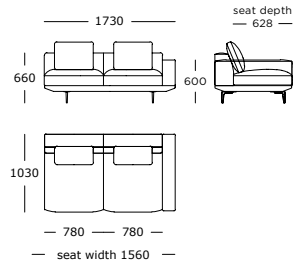

Module 3

2 seater, back left

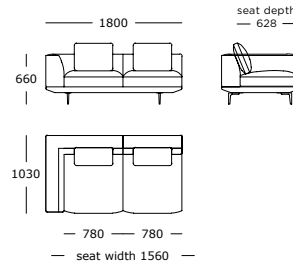

Module 4

2 seater, back right

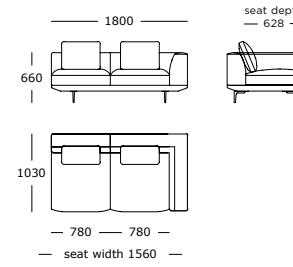

Module 5

Corner

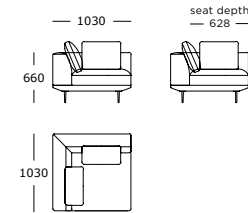

Module 6

Stool

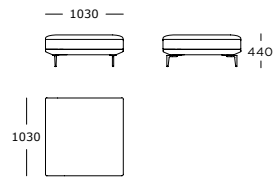

Module 7

Chaise wide arm, left wooden tray

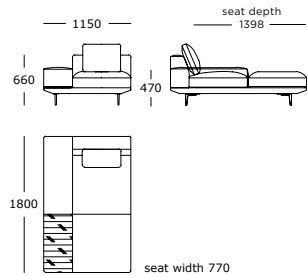

Module 8

Chaise wide arm, right wooden tray

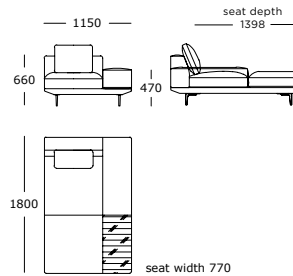

Module 9

2 seater, wide left arm

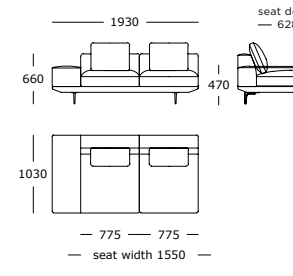

Module 10

2 seater, wide right arm

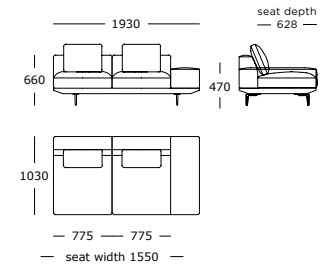

Module 11

2 seater, wooden tray left

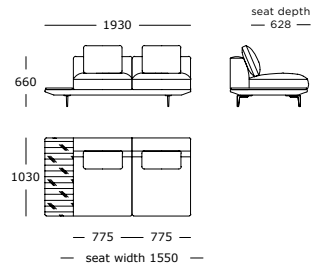

Module 12

2 seater, wooden tray right

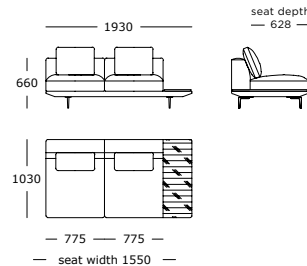

Module 13

1 seater, wide left arm

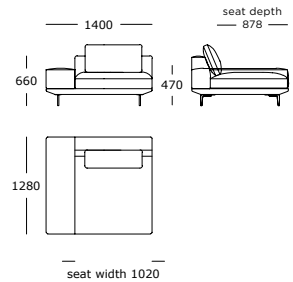

Module 14

1 seater, wide right arm

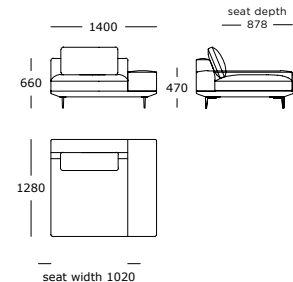

Module 15

1 seater, wooden tray left

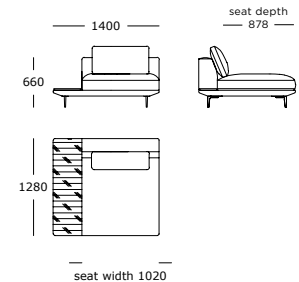

Seat height: 440 mm
Wooden tray height: 240 mm

Surface / Module overview

Index



Fabrics



Leather



Module 16

1 seater, wooden tray right

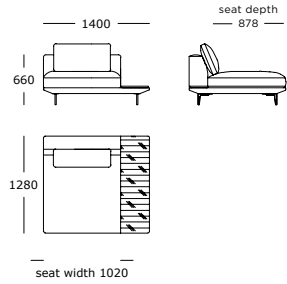

Module 17

Centre XL

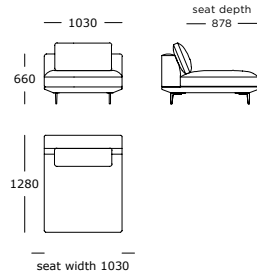

Module 18

2 seater, centre

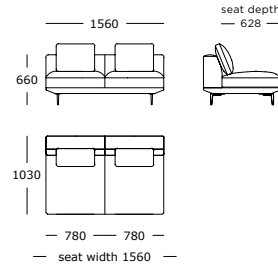

Module 19

Chaise, wide arm left

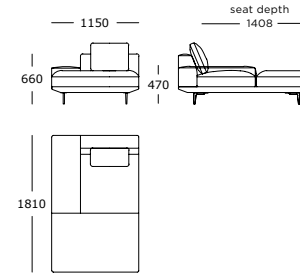

Module 20

Chaise, wide arm right

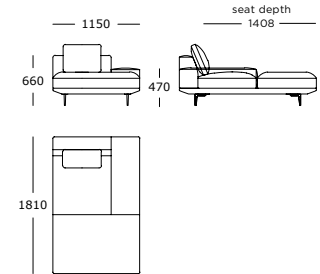

Module 21

Centre

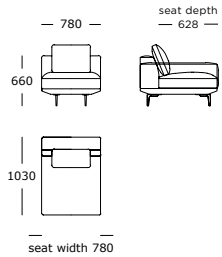

Module 22

1 seater, wooden tray left

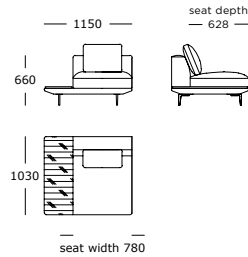

Module 23

1 seater, wooden tray right

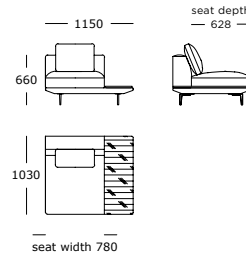

Module 24

1.5 seater, open end left

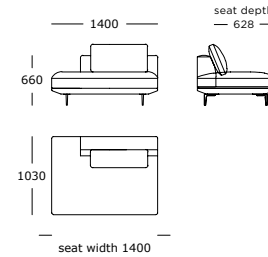

Module 25

1.5 seater, open end right

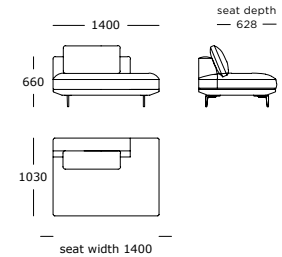

Module 26

2 seater/corner, back right, wooden tray left

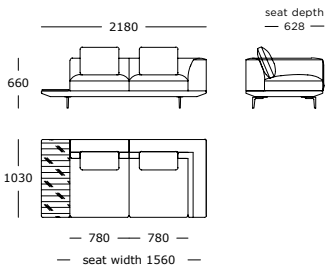

Module 27

2 seater/corner, back left, wooden tray right

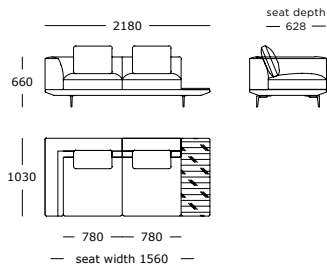

Module 28

2.5 seater, corner, open end left

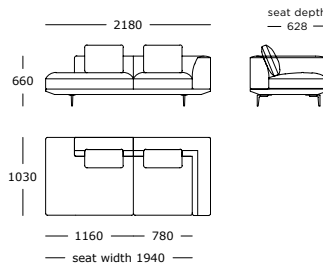

Module 29

2.5 seater, corner, open end right

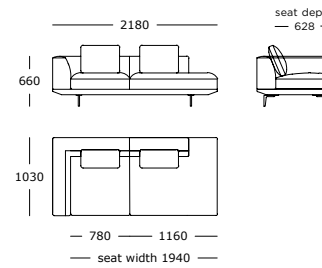

Module 30

1 seater, slim arm left

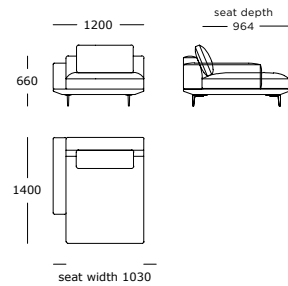

Seat height: 440 mm
Wooden tray height: 240 mm

Surface / Module overview

Index



Fabrics



Leather



Module 31

1 seater, slim arm right

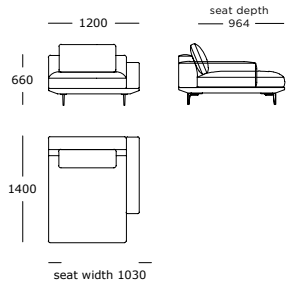

3 seater

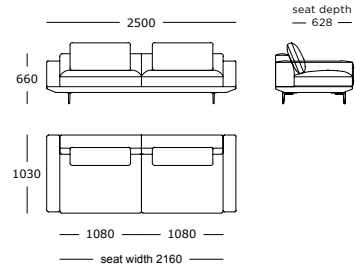

2.5 seater

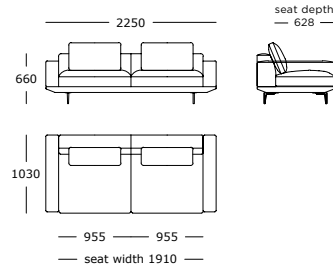

2 seater

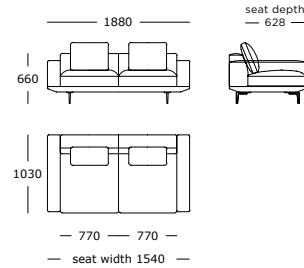

Slim tall arm
H = 560 mm / W = 190 mm

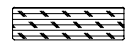

Wooden tray
H = 240 mm / W = 360 mm



Low wide arm
H = 470 mm / W = 380 mm



Normal back
H = 660 mm / W = 270 mm

Seat height: 440 mm
Wooden tray height: 240 mm

Surface / Module overview

Index



Fabrics



Leather



Configuration 1

Modules 30 + 25

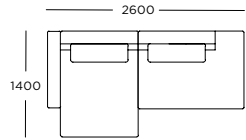

Configuration 2

Modules 28 + 2

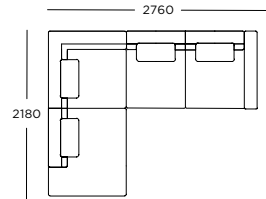

Configuration 3

Modules 11 + 20

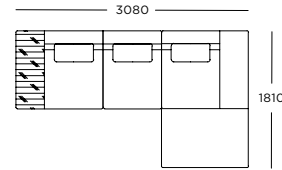

Configuration 4

Modules 1 + 4 + 12

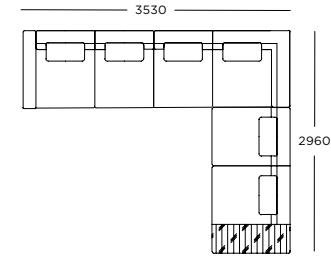

Configuration 5

Modules 24 + 18 + 27

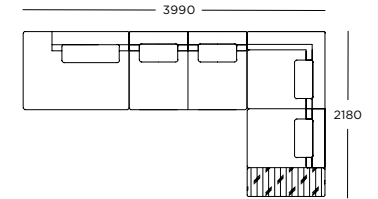

Configuration 6

2 x Modules 24 + 25

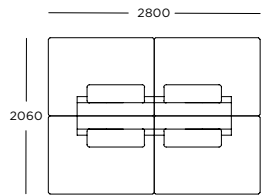

Configuration 7

Modules 1 + 3 + 25

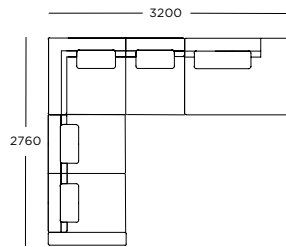

Configuration 8

Modules 1 + 23

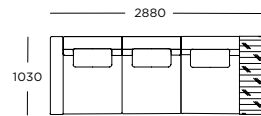

Configuration 9

Modules 13 + 17 + 16

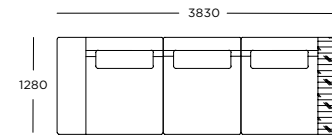



Trace /

Lines of comfortable firmness

Contributing to an upright and poised seating experience, the Trace Sofa bridges sharp exterior lines with the comfortable firmness of the interior. Offered in 16 modules, the sleek legs crafted from black powder-coated steel introduce a sophisticated visual contrast.

DESIGNER

365 North

CATEGORY

Sofas
Modular sofas

TEST

BIFMA

ASSEMBLY

Follow assembly instructions for mounting of legs

LEGS

Black powder-coated steel



STRUCTURE INTERIOR

Frame made of solid wood, plywood and MDF with elastic webbing suspension

STRUCTURE PADDING

High-resilient, variable density, polyurethane foam with dacron padding

COVER

Fixed

SEAT

High-resilient, variable density, polyurethane foam with 50/50 feather and ball fibre top in downproof cambric bag divided into channels

BACK CUSHION

50/50 feather and ball fibre top in downproof cambric bag divided into channels

CONTRACT VERSION

Seat and back cushion: High-resilient foam with dacron padding

Same price as standard version

MAINTENANCE

To ensure the longevity of your product, please follow our care and maintenance guides. All guides can be downloaded at wendelbo.com/care

WARRANTY

5 years

1 seater

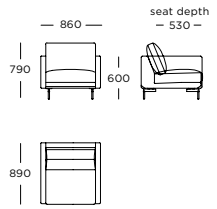

2 seater

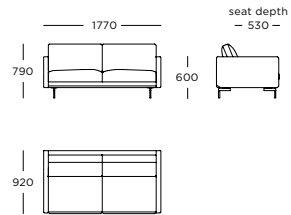

2.5 seater

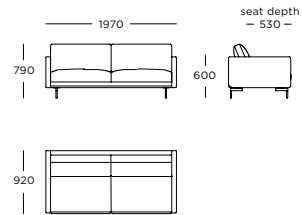

3 seater

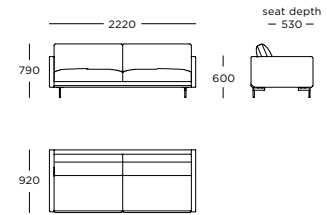

Ottoman

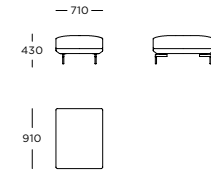

Seat height: 430 mm

Trace / Sofa overview

Index



Fabrics



Leather



Module 1

2 seater, left arm

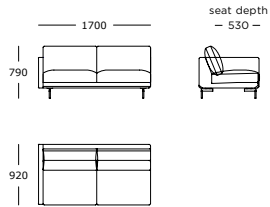

Module 2

2 seater, right arm

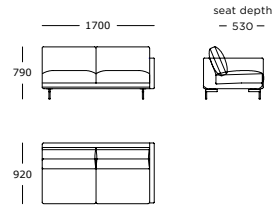

Module 3

2.5 seater, left arm

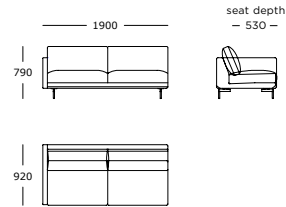

Module 4

2.5 seater, right arm

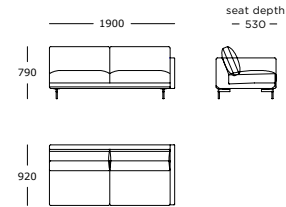

Module 5

3 seater, left arm

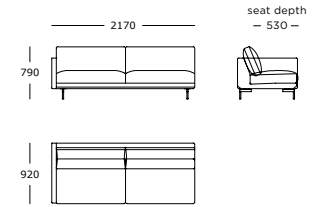

Module 6

3 seater, right arm

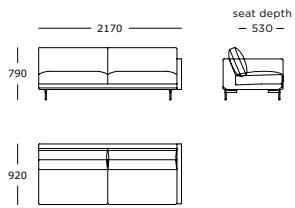

Module 7

End terminal, left

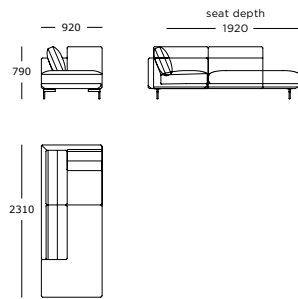

Module 8

End terminal, right

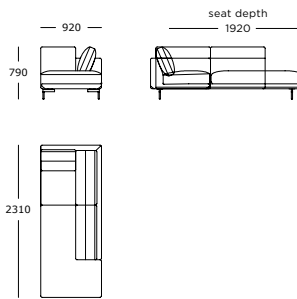

Module 9

Chaiselong, left

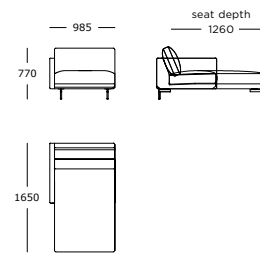

Module 10

Chaiselong, right

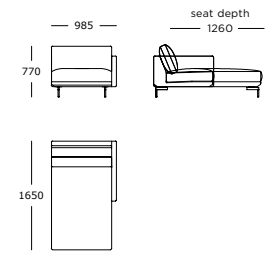

Module 11

Corner

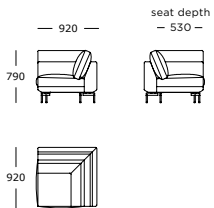

Seat height: 430 mm

Trace / Module overview

Index



Fabrics



Leather



Configuration 1

Modules 9 + 2

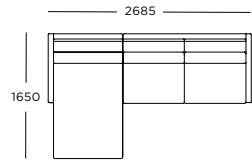

Configuration 2

Modules 1 + 2

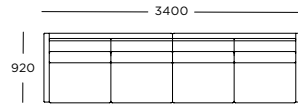

Configuration 3

Modules 3 + 8

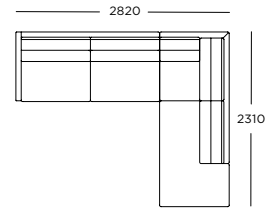

Configuration 4

Modules 3 + 11 + 6

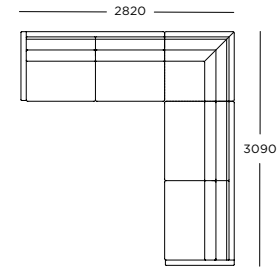

Price groups

1

Delphi | Wendelbo
Glow | Wendelbo
Lava | Wendelbo

2

Autumn | Kvadrat
Blend | Gabriel
Cala* | Wendelbo
Connect | Gabriel
Cura | Gabriel
Cyber | Gabriel
Guest | Kvadrat
North | Wendelbo
Renewed Loop | Gabriel
Soft | Wendelbo
Tempt | Gabriel

3

Alma | Wendelbo
Amaze Loop | Gabriel
Geneva | Villa Nova
Grain | Gabriel
Jamie | Wendelbo
Mainline ^{FLAX} | Camira
Mainline ^{TWIST} | Camira
Metaphor | Maharam
Noma | Gabriel
Parcel Loop | Gabriel
Remix | Kvadrat
Roco | Wendelbo
Sahara | Kirby Design
Sasso | Wendelbo
Softnext | Gabriel
Solo | Delius
Tivoli | Wendelbo
Zest | Wendelbo

4

Agata | Wendelbo
Blazer | Camira
Bosa | Wendelbo
Coast | Wendelbo
Comfort* | Wendelbo
Linara | Romo
Messenger | Maharam
Mode | Maharam
Monta | Wendelbo
Navona | Wendelbo
Senza | Wendelbo
Spectrum | Wendelbo
Step Melange | Gabriel
Synergy | Camira

5

Amdal | GU
Atlantis | Villa Nova
Bardal | GU
Capture | Gabriel
Crisp | Gabriel
Cuddle | Wendelbo
Fiord | Kvadrat
Gandal | GU
Hot Madison | Chivasso
Julie | Wendelbo
Linara FR | Romo
Maple | Kvadrat
Melange Nap | Kvadrat
Merit | Maharam
Morph | Gabriel
Passion | Gabriel
Re-wool | Kvadrat
Silenzio | Wendelbo
Smooth | Kirby Design
Sport | Kvadrat
Steelcut | Kvadrat
Steelcut ^{TRIO} | Kvadrat
Steelcut ^{QUARTET} | Kvadrat
Tailor | Gabriel
Umber | Gabriel

6

Atlantis FR | Villa Nova
Canvas 2 | Kvadrat
Focus Royal | Gabriel
Haku | Kvadrat
Hero | Kvadrat
Ruskin | Romo
Yoredale | Camira

7

Breeze Fusion | Gabriel
Craggan Flax | Camira
Ecriture | Sahco
Hero Heather | Kvadrat
Mood | Gabriel
Ruskin FR | Romo
Savoy | Gabriel

8

Hallingdal | Kvadrat
Harald 3 | Kvadrat
Moss | Sahco
Nobel | Gabriel
Savanna | Kvadrat
Sunniva 3 | Kvadrat
Vidar | Kvadrat
Zero | Sahco

9

Patrol | Wendelbo

10

Barona | Wendelbo
Faith | Wendelbo
Parma | Wendelbo

11

Treviso | Wendelbo

Fabric

Fabric	Supplier	Composition	BS EN 1021 1 Cigarette	BS EN 1021 2 Match	BS 5852 CRIB 5	CAL TB 117	Width	Martindale	Light fastness	Pilling	Price group	Price pr. m
● Agata	Wendelbo	30% VI/16% WO/13% LI/12% CO/10% PA	X			X	140 cm	30.000	5-6	3-4	4	108
● Alma	Wendelbo	37% PL/21% PC/19% VI/14% CO/8% LI/1% PA	X			X	140 cm	40.000	5-6	3-4	3	81
Amaze Loop	Gabriel	100% POST-CONSUMED REC. PES	X	X	X	X	140 cm	40.000	7-8	4-5	3	81
Amdal	GU	70% WO/30% VI	X	X	X	X	140 cm	100.000	5-7	3-4	5	130
Atlantis	Villa Nova	100% PL				X	140 cm	100.000	5	-	5	130
Atlantis FR	Villa Nova	100% PL	X	X	X		140 cm	100.000	5	-	6	141
Autumn	Kvadrat	100% RECYCLED PL	X	X		X	140 cm	50.000	6-7	4	2	54
Bardal	GU	70% WO/30% VI	X	X	X	X	140 cm	62.500	5-7	4	5	130
Blazer	Camira	100% VIRGIN WO	X	X		X	140 cm	50.000	5	4	4	108
Blend	Gabriel	100% RECYCLED PL	X	X		X	140 cm	100.000	7-8	4-5	2	54
● Bosa	Wendelbo	5% CO/15% LI/5% PA/40% PC/20% PL/5% VI	X			X	140 cm	50.000	5	3-4	4	108
Breeze Fusion	Gabriel	88% WO/8% PA	X	X		X	140 cm	100.000	5-7	4-5	7	151
● Cala*	Wendelbo	80% CO/20% PL	X			X	140 cm	40.000	5	4	2	54
Canvas 2	Kvadrat	90% WO/10% NY	X	X		X	140 cm	100.000	6	4	6	141
Capture	Gabriel	85% WO/15% PA	X	X		X	140 cm	200.000	5-7	4-5	5	130
● Coast	Wendelbo	20% CO/25% PC/25% PL/30% VI	X			X	140 cm	30.000	5	4	4	108
● Comfort*	Wendelbo	80% PL/20% CO	X				140 cm	100.000	3-5	5	4	108
Connect	Gabriel	48% WO/41% PCR/9% PA/2% PES	X	X	X	X	140 cm	90.000	5-7	4-5	2	54
Craggan Flax	Camira	85% WO/20% CO	X	X	X	X	140 cm	50.000	5	3-4	7	151
Crisp	Gabriel	93% WO/7% PL	X	X		X	140 cm	200.000	5-7	4-5	5	130
● Cuddle	Wendelbo	34% VI/33% PC/17% WO/8% PL/4% LI/4% CO	X	X		X	140 cm	80.000	4-5	5	5	130
Cura	Gabriel	98% REC. PL/2% PL	X	X		X	140 cm	100.000	5-8	4-5	2	54
Cyber	Gabriel	100% POST-CONSUMER REC. PL	X	X		X	140 cm	100.000	5-8	4-5	2	54
● Delphi	Wendelbo	47% CO/47% VI/6% LI	X	X		X	140 cm	30.000	3	4	1	43
Ecriture	Sacho	40% PA/27% PL/18% VI/9% LI/6% CO	X	X		X	140 cm	70.000	6	4-5	7	151
Fiord	Kvadrat	92% WO/8% NY	X	X		X	140 cm	60.000	6	4-5	5	130
Focus Royal	Gabriel	100% NEW ZEALAND WOOL	X	X		X	140 cm	100.000	5-8	4-5	6	141
Gandal	GU	96% WO/4% PA	X	X		X	140 cm	80.000	5-7	4	5	130
Geneva	Villa Nova	60% CO/40% LI	X				138 cm	40.000	5	-	3	81
● Glow	Wendelbo	100% PES				X	140 cm	50.000	4-5	4-5	1	43

Fabric	Supplier	Composition	BS EN 1021 1 Cigarette	BS EN 1021 2 Match	BS 5852 CRIB 5	CAL TB 117	Width	Martindale	Light fastness	Pilling	Price group	Price pr. m
Grain	Gabriel	92% RECYCLED PL/ 8% PL	X	X		X	140 cm	100.000	-	4-5	3	81
Guest	Kvadrat	100% RECYCLED PL	X	X		X	140 cm	100.000	5-7	4	2	54
Haku	Kvadrat	100% POLYURETHANE/SILICONE	X			X	140 cm	100.000	7	5	6	141
Hallingdal 65	Kvadrat	70% WO/30% VI	X	X	X	X	130 cm	100.000	7	3-4	8	162
Harald 3	Kvadrat	100% CO	X				140 cm	100.000	5	4-5	8	162
Hero	Kvadrat	97% WO/3% RECYCLED NYLON					140 cm	45.000	6	3-4	6	141
Hero Heather	Kvadrat	97% WO/3% RECYCLED NYLON					140 cm	45.000	6	3-4	7	151
Hot Madison	Chivasso	63% CO/37% LI					140 cm	55.000	4-5	-	5	130
Jamie	Wendelbo	64% CO / 36% VI		X			140 cm	30.000	4-5	4-5	3	81
Julie	Wendelbo	25% CO / 25% LI / 20% PL / 30% WO	X			X	140 cm	40.000	5	3-4	5	130
Lava	Wendelbo	43% PL / 57% CO				X	145 cm	30.000	3	4-5	1	43
Linara	Romo	63% CO/37% LI	X			X	140 cm	36.000	5	-	4	108
Linara FR	Romo	63% CO/37% LI	X	X	X		140 cm	36.000	5	-	5	130
Main Line ^{FLAX}	Camira	70% WO/30% LI	X	X	X	X	140 cm	50.000	5	4	3	81
Main Line ^{TWIST}	Camira	75% VIRGIN WO/25% FLAX	X	X	X	X	140 cm	50.000	4-5	3-4	3	81
Maple	Kvadrat	81% VI/15% LI/4% PL	X	X		X	140 cm	30.000	5	4-5	5	130
Melange Nap	Kvadrat	97% WO/3% NY	X	X		X	140 cm	60.000	6	3-4	5	130
Merit	Maharam	76% REC. PL/24% PL				X	137 cm	100.000	5-6	4	5	130
Messenger	Maharam	78% REC. PL/15% PL / 7% NY				X	137 cm	100.000	6-7	4	4	108
Metaphor	Maharam	100% PL				X	137 cm	100.000	4-6	4.5	3	81
Mode	Maharam	80% REC. PL/20% PL				X	137 cm	100.000	5-6	4	4	108
Monta	Wendelbo	30% PL/28% PC/21% VI/12% CO/9% LI	X			X	140 cm	40.000	5-6	4	4	108
Mood	Gabriel	98% WO/2% PA	X	X		X	140 cm	95.000	5-7	4	7	151
Morph	Gabriel	85% NEW ZEALAND WO/15% PL	X	X	X	X	140 cm	100.000	5-6	4	5	130
Moss	Sahco	52% CO/22% VI/14% P.A./6% LI/3% PL/3 NY	X	X			140 cm	50.000	6	4-5	8	162
Navona	Wendelbo	32% PC / 29% CO / 26% VI / 10% LI / 3% PL					140 cm	30.000	4-5	4	4	108
Nobel	Gabriel	100% NEW ZEALAND WOOL	X	X	X	X	140 cm	75.000	5-7	4-5	8	162
Noma	Gabriel	50% REC. PL/50% PL	X	X	X	X	140 cm	60.000	5-8	4-5	3	81
North	Wendelbo	70% WO / 20% PL / 5% PA / 5% PC	X	X		X	145 cm	60.000	5	3-5	2	54
Parcel Loop	Gabriel	100% POST-CONSUMED REC. PES	X	X		X	140 cm	100.000	6-8	4-5	3	81
Passion	Gabriel	91% NEW ZEALAND WO/9% PA	X	X	X	X	140 cm	200.000	5-7	4-5	5	130
Remix	Kvadrat	90% WO/10% NY	X	X		X	138 cm	100.000	5	4	3	81
Renewed Loop	Gabriel	100% REC. PL					140 cm	100.000	7-8	4-5	2	54
Re-wool	Kvadrat	90% WO/10% NY	X	X		X	140 cm	100.000	7	4	5	130
Roco	Wendelbo	32% CO / 48% PC / 20% PL	X			X	140 cm	40.000	5	4	3	81

Fabric	Supplier	Composition	BS EN 1021 1 Cigarette	BS EN 1021 2 Match	BS 5852 CRIB 5	CAL TB 117	Width	Martindale	Light fastness	Pilling	Price group	Price pr. m
Ruskin	Romo	70% VI/15% LI/10% WO/5% PA	X	X			140 cm	60.000	5	3-4	6	141
Ruskin FR	Romo	70% VI/15% LI/10% WO/5% PA	X	X	X		140 cm	60.000	5	3-4	7	151
Sahara	Kirkby Design	100% CO	X			X	140 cm	65.000	5	-	3	81
● Sasso	Wendelbo	55% VI/9% PL/18% LI/13% CO/5% PC	X	X			140 cm	25.000	3-5	2-3	3	81
Savanna	Kvadrat	34% PL/31% WO/26% P.A./4% CO/2% NY/2% LI	X	X		X	140 cm	45.000	6-7	3	8	162
Savoy	Gabriel	100% TREVIRA CS	X	X	X	X	140 cm	100.000	5-8	5	7	151
● Senza	Wendelbo	100% CO				X	140 cm	70.000	3-5	2	4	108
● Silenzio	Wendelbo	5% CO/15% LI/30% WO/25% PC/20% PL ETC.	X			X	140 cm	30.000	5	4	5	130
Smooth	Kirkby Design	100% PL				X	140 cm	100.000	5	-	5	130
● Soft	Wendelbo	47% PL / 43% AC / 10% CO	X	X		X	140 cm	50.000	5	3-4	2	54
Softnext	Gabriel	100% POST-CONSUMER REC. POLYESTER					140 cm	80.000	7-8	4-5	3	81
Solo	Delius	100% PU WITH PES/CO-COATING	X	X			140 cm	300.000	6-7	-	3	81
● Spectrum	Wendelbo	72% PC/14% VI/9% WO/5%PL	X	X		X	140 cm	30.000	4-5	5	4	108
Sport	Kvadrat	100% OCEAN BOUND PL	X	X		X	140 cm	40.000	7	4-5	5	130
Steelcut	Kvadrat	90% NEW WO. WORSTED/10% NY	X	X		X	140 cm	100.000	5	3-4	5	130
Steelcut ^{QUARTET}	Kvadrat	90% NEW WO. WORSTED/10% NY.	X	X			140 cm	100.000	6-7	4-5	5	130
Steelcut ^{TRIO}	Kvadrat	90% WO/10% NY	X	X		X	140 cm	80.000	5	4	5	130
Step Melange	Gabriel	100% TREVIRA CS	X	X	X	X	140 cm	100.000	5-7	4-5	4	108
Sunniva 3	Kvadrat	58% WO/25% VI/8% LI/5% NY/4% PL	X	X		X	140 cm	50.000	5	3	8	162
Synergy	Camira	95% VIRGIN WO/5% PL	X	X		X	140 cm	100.000	4	4	4	108
Tailor	Gabriel	90% NEW ZEALAND WOOL / 10% POLYAMIDE	X	X	X	X	140 cm	100.000	5-7	4-5	5	130
Tempt	Gabriel	100% PL	X	X		X	140 cm	100.000	5-8	4-5	2	54
● Tivoli	Wendelbo	42% VI / 38% CO / 14% PC / 6% PES	X	X		X	140 cm	30.000	5	3-4	3	81
Umber	Gabriel	85% NEW ZEALAND WO / 15% POLYAMIDE	X	X	X	X	140 cm	200.000	5-6	4-5	5	130
Vidar	Kvadrat	94% WO / 6% NY	X	X		X	140 cm	100.000	7	4	8	162
Yoredale	Camira	95% WO/3% PL/2% PA	X	X		X	138 cm	50.000	5	4	6	141
Zero	Sahco	65% CO/20% POL/15% PL	X			X	140 cm	70.000	6	5	8	162
● Zest	Wendelbo	100% PC	X	X		X	140 cm	100.000	5	5	3	81

Leather

Leather	Supplier	Description	BS EN 1021 1 Cigarette	BS EN 1021 2 Match	BS 5852 CRIB 5	CAL TB 117	Thickness	Price group	Price pr. m ²
Barona	Wendelbo	Soft leather, corrected grain	X	X	X	X	0.9 - 1.1 mm	10	141
Faith	Wendelbo	Full grain, aniline leather	X	X	X	X	1.3 - 1.5 mm	10	141
Parma	Wendelbo	Full grain, aniline leather	X	X	X	X	0.9 - 1.1 mm	10	141
Patrol	Wendelbo	Semi aniline, corrected grain	X	X	X	X	1.2 - 1.4 mm	9	108
Treviso	Wendelbo	Full grain, aniline leather	X	X	X	X	1.0 - 1.2 mm	11	162

Testing standards

Product	Tested on	EN 16139	EN 16121	EN 12520	EN 581	EN 15372	BIFMA	GB
Aero	Chair Large	X						X
Aloe	Chair	X					X	
Blade	Module 22	X						
Campo	Module 2	X						
Canoe	Daybed	X						
Case	1.5 seater	X					X	
	2 seater	X						X
Chill	Chair Low back	X					X	
	Chair High back							X
Cinder Block	Modules 1 and 8	X						
Coin	Dining Table					X		X
Collar	Chair Large	X					X	X
Collect	Medium, Large and Round Side Table					X		
Define	Module 2	X						
Edge	V1 Module 17	X						X
Event	V1 Module 25						X	
	Chair V1 and Chair V2						X	
Expose	Large Coffee Table					X		
Floema	Small (Marble and Walnut) and Medium (Marble) Oval and Medium (Marble)					X		X
Folium	Dining Chair, Lounge Chair and Bar Stool						X	
Hang	Module 1 and 6	X						
Hug	Chair	X					X	
	Sofa							X
Kite	Module 1	X						
Lilin	2.5 seater						X	
	2.5 seater Curved							X
Lobby	Module 6	X					X	
Maho	Module 6	X						

Product	Tested on	EN 16139	EN 16121	EN 12520	EN 581	EN 15372	BIFMA	GB
Mango	Chair			X			X	X
	Mini Chair	X						
Mono V1	Chair V1	X			X			X
	Chair V2	X						X
	Chair V3	X					X	X
Montholon	Chair Swivel with return	X						
Nova	Module 12	X						
Ovata	Lounge Chair	X						
	High Back Lounge Chair	X						X
	Dining Chair	X					X	
	Bar Stool						X	
Panorama	Module 1	X						
	Module 6	X						X
Panorama Dine	Module 3 + 12						X	
Poller	Large Table					X		X
Pontone	Module 12	X						
Rest	1.5 seater Left	X					X	
Sepal	Dining Chair and 2 seater	X					X	X
Sinum	Dining Chair (Tube base)						X	
Slice	Medium/Medium		X					
Surface	Module 4 and 7	X						
	3 seater							X
Trace	3 seater						X	
Versu	Chair V1	X					X	
Vista	Chair and 2 seater	X					X	X

Testing standard explanation

EN 12520: Strength, durability and safety requirements for domestic seating

EN 16139: Strength, durability and safety requirements for non-domestic seating

EN 581: General safety requirements, mechanical safety requirements and test methods for seating

EN 15372: Strength, durability and safety requirements for non-domestic table

BIFMA: Durability, structural performance, and safety of Lounge and Public Seating used in a commercial office environment

GB: National Chinese standard for indoor decorating and refurbishing materials - limit of harmful substance of wood based furniture

Spare parts overview

To prolong the lifespan of our designs, we offer spare parts for most of our products. Below, you will find an overview of the spare parts available for each design. Please note that prices are available upon request.

Product	Cover	Seat/back cushion cover	Seat/back cushion filling	Legs/Base	Tabletop	Shelves	USB plug	Tray	Castors	Connection joints
Aero		x	x	x						
Aloe				x						
Arc				x	x					
Blade	x	x	x	x						x
Boketto				x			x	x		x
Calibre										
Campo	x	x	x	x						x
Canoe				x				x		
Case		x	x				x			
Chill				x						
Cinder Block		x**	x					x		x
Circle				x	x					
Coin										
Collar				x	x					
Collect				x	x					
Define		x**	x							x
Duvet				x						
Edge V1	x	x	x	x						x
Edge V2	x	x	x	x						x
Elba										
Event				x						
Expose				x	x					
Floema				x	x					
Folium				x						
Formal				x		x				
Glyph				x	x					
Hang				x						x
Hug		x***	x	x						

* If ordered with loose cover
 ** Only back cushion
 *** Only seat cushion

Spare parts overview

Product	Cover	Seat/back cushion cover	Seat/back cushion filling	Legs/Base	Tabletop	Shelves	USB plug	Tray	Castors	Connection joints
Kite		x	x	x						x
Lilin				x						
Lobby				x						
Maho	x	x	x	x				x		x
Mango				x						
Mate				x	x					
Mono				x						
Montholon				x						x
Notch				x	x					
Nova	x*	x	x	x						x
Ovata Lounge				x						
Ovata Chair				x						
Ovata Table				x	x					
Panorama				x			x			x
Panorama Dine Sofa				x			x			x
Panorama Dine Table				x	x					
Parlour				x						
Poller				x	x					
Pontone	x	x	x	x						x
Raya										
Rest										
Root				x	x					
Sepal										
Sinum				x					x	
Slice				x		x				
Surface		x	x	x				x		x
Tip Toe				x						
Trace		x	x	x						x
Vector				x	x					
Versu				x						
Vista				x						
Wedge				x	x					

* If ordered with loose cover
 ** Only back cushion
 *** Only seat cushion

Spare parts overview

Sales terms and conditions

Additional charges

COM fabrics: EUR 195 (per order)

The packaged COM fabrics must be clearly marked with Wendelbo order number, as well as country of origin, composition, tariff code, fabric width and weight g/m².

Sales terms and warranty

Wendelbo reserves the right to withdraw or modify models without prior notice. All rights reserved against price and printing errors or out-of-stock products. Danish Wood & Furniture Industries General Conditions of Sale & Terms of Delivery applies; however, Wendelbo offers a 5-year warranty on all furniture in our collection and a 2-year warranty on all rugs. The 5-year warranty applies to all furniture purchased after January 1, 2023.

Cancellation policy

Please note that an order is considered binding from the order confirmation has been sent from Wendelbo.

If the Buyer wishes to make any changes or cancellations, please find our cancellation/change policy below:

Time from order confirmation has been sent	Cancellation / Change fee in % of order value
0 hrs. up to 48 hrs.	0%
48 hrs. up to 8 days	25%
After 8 days	100%

Re-orders

Reservations must be made for minor adjustments in colour, density and dimensions, as we continuously develop and update our designs.

Extra loose cover

40% of sofa price

Dimensions

Reservations must be made for minor deviations.

Fabric consumption

All fabric consumption is calculated based on a standard fabric width of 140 cm. As a result, seam lines may appear on larger sofa modules.

Leather

Leather upholstery is always fixed. Being a natural material, each leather surface is unique, and variations in appearance are to be expected.

Like fabric, seam lines may also occur on larger sofa modules upholstered in leather.

Marble and limestone

Reflecting the unique terroir of their origins, visual variations in colour, fossil markings and veining are to be expected in our selection of marbles and limestone. Not to be mistaken for cracks, the veins can appear as small lines or run through the entire slab. No matter the volume, the tabletop's stability will not be affected by the veins and these natural variations should not be considered defects, nor are they covered by our warranty.

Contact information

Wendelbo A/S

Mosevej 20A

8240 Risskov

Denmark

+45 87 400 800

info@wendelbo.dk

www.wendelbo.dk

General conditions of sale and terms of delivery

For members of the Association of Danish Wood & Furniture Industries

Application	The following General Conditions of Sale and Terms of Delivery shall apply to all offers, sales and deliveries by the Vendor - also in cases where the Buyer stipulates other terms and conditions. Any deviation from the following Conditions of Sale and Terms of Delivery shall only be valid subject to the written consent of the Vendor.
Article 01	Delivery clauses: Any agreed terms of delivery shall be construed in accordance with the Incoterms applying at the time of conclusion of the contract. Where no special term of delivery has been stipulated, the delivery shall be deemed to have been made "ex works".
Article 02	Insurance: Unless otherwise agreed, the Buyer shall take out a transport insurance policy. Moreover, the Buyer shall undertake to keep the goods insured.
Article 03	Delays by vendor: If the Vendor becomes aware that he will be unable to meet the stipulated time of delivery, or that a delay on his part is likely to occur, he shall without undue delay notify the Buyer in writing thereof stating the cause of the delay and, wherever possible, the time when delivery is likely to take place. Where a delay in delivery is due to any of the circumstances set forth in Article 9 hereof ("force majeure") or to acts or omissions on the part of the Buyer, the time of delivery shall be postponed to such an extent as is deemed to be reasonable, having regard to the circumstances. This provision shall apply whether the cause of delay occurs before or after the end of the stipulated time of delivery. The Buyer shall not be entitled to cancel the contract owing to delays in delivery attributable to the Vendor except where such delay exceeds three (3) months. The Buyer shall not be able to claim compensation owing to delays on the part of the Vendor.
Article 04	Delays by buyer: If the Buyer becomes aware that he will not be able to take delivery of the goods by the stipulated date - or if a delay on his part is likely to occur - he shall forthwith notify the Vendor in writing, stating the cause of delay and, wherever possible, the time when receipt is likely to be able to take place. Notwithstanding that the Buyer fails to take delivery of the goods at the stipulated time, he shall make any payment contingent upon delivery as if delivery of the relevant goods had taken place. The Vendor shall make sure that the goods are stored for the Buyer's account and at the Buyer's risk. The Vendor shall at the Buyer's request insure the goods for the Buyer's account. The Vendor shall have the right to call upon the Buyer in writing to take delivery of the goods within a time-limit of fifteen (15) days. Where the Buyer fails to do so within the same time-limit for reasons that are not attributable to the Vendor, the Vendor shall be entitled to cancel the contract by notice in writing to the Buyer, for such part of the goods ready for delivery as was not taken delivery of owing to the Buyer's delay. In such case, the Vendor shall have the right to demand compensation for any loss he has incurred from the Buyer's failure to perform the contract.
Article 05	Payment etc.: Unless otherwise agreed, the purchase sum shall be payable in cash upon delivery of the goods. Where the Buyer fails to effect payment punctually, the Vendor shall be entitled to demand penal interest as from the due date at the rate of 1.5% per month or part thereof. Where the Buyer wishes to return goods delivered, such return shall be made only as per prior agreement with the Vendor. Returned goods shall be sent carriage paid. In the event of nonpayment, the Buyer (debtor) shall pay all costs of collecting and recovering the debt, inclusive of charges and fees for lawyers, debt-collection agencies etc.
Article 06	Ownership reservation (Retention of title): The goods sold shall remain the Vendor's property until payment has been made in full. As for sales to Germany, however, the retention of title stipulated in the enclosed addendum D98 shall apply.
Article 07	Defects: The Vendor agrees to make good all such defects as are the result of faulty design, material, or workmanship by carrying out repairs or replacement delivery of the goods in accordance with the following paragraphs, but the Vendor shall incur no liability to pay compensation as a result of such defects. As far as wood is concerned, minor knots and differences in shade and structure shall not be regarded as defects. As far as leather is concerned, growth marks shall not be regarded as defects, but as a sign of genuineness. The Vendor's liability shall comprise only such defects as appear within twenty-four (24) months from the date when the goods were delivered to the Buyer. The Buyer shall notify the Vendor in writing of any defects without undue delay after such defects have appeared.



- Article 08 **Product liability:** The Vendor shall be liable for damage to property caused by the products only where it can be shown that such damage was due to fault or negligence on the part of the Vendor or his employees. Under no circumstances shall the Vendor be liable for loss of profits, loss of earnings, or any other consequential financial loss. In the event that the Vendor incurs products liability towards any third party, the Buyer shall indemnify the Vendor to the same extent as the Vendor's liability is limited according to the above. If any third party raises a claim for compensation against the Buyer by reason of a product damage, the Buyer shall forthwith notify the Vendor to this effect.
- Article 09 **Force majeure:** The following circumstances with the Vendor shall give rise to exemption from liability if they prevent the performance of the contract or render such performance unreasonably onerous: Labour conflicts and any other circumstance beyond the control of the Vendor, such as but not limited to fire, war, mobilisation or unforeseen military call-ups of a corresponding scale, requisitioning, seizure, foreign exchange restrictions, insurrection and civil unrest, lack of transportation except where such lack was foreseeable by the Vendor, general scarcity of goods, and defects in or delays of deliveries from subsuppliers due to any of the factors set forth in this paragraph. Circumstances of the type mentioned above, which had occurred prior to the conclusion of this Agreement, shall exempt the Vendor from liability only where their influence on the performance of the contract could not be foreseen by the Vendor at the time when the contract was made. Where the Vendor intends to invoke any exemption-from-liability grounds set forth in this Article, he shall without undue delay notify the Buyer in writing of such grounds. Notwithstanding any stipulation in these Conditions of Sale and Terms of Delivery, either of the parties may cancel the agreement by notice in writing to the other party where the performance of the agreement is prevented for more than six (6) months by one of the events set forth in this Article.
- Article 10 **Disputes:** All and any disputes arising out of or in connection with this contract shall be settled according to Danish law. Any legal action shall be instituted at the Vendor's or Buyer's venue, at the Vendor's option.